



CS 50 VISION SENSOR

QUICK START INSTRUCTIONS

THE FIRST STEPS TO SCREEN 1



- Unpack the CS 50, mount it mechanically and install its electrical wiring (4.75-30V DC). Here, two connection cables are required at a minimum VKHM-Z-5/12-A (Power I/O and electrical connection, see page 2) and VKHM-Z-5/RJ-45 (Ethernet cable M12-RJ45 for set-up).
- Download and install the most recent software for the CS 50:
<https://www.di-soric.com/de/Vision-sensor-CS-50-di-soric-59773.html>
You will find all the necessary ports in the list on page 3. To ensure that AutoVision is installed properly, full administrative rights are required. If applicable, configure network settings on the computer.
- Each CS 50 is delivered with a static IP address. IP 192.168.0.10 / Sub 255.255.0.0
- To ensure a stable connection, static IP addresses should be used in the network. If multiple CS 50 sensors are being used, the IP addresses must be configured to prevent a network conflict.
- After AutoVision has been started, the the image on the left image appears and the option to select a device or the emulator becomes available in the drop-down menu in the upper left.

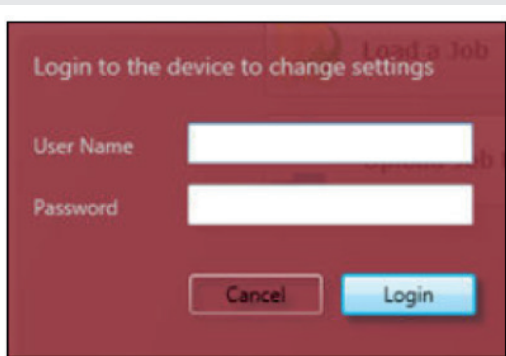

- Once the desired CS 50 has been selected, the red “Login” window appears once per device.
- When the device is first delivered, there is no user name or password, please confirm by clicking “Login” without entering anything.
- Then, you can continue by clicking “Create a New Job”

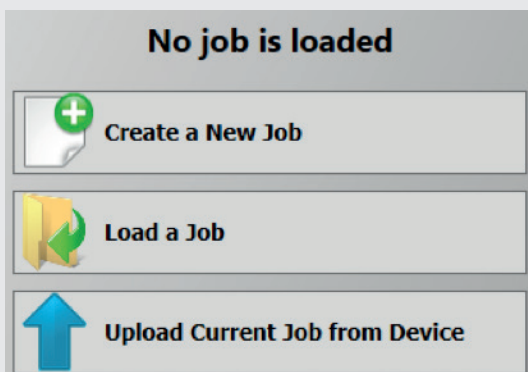

At this point, you will see the first screen of the “Image” menu item and be able to begin image set-up



CS50 SENSOR PORTS

SENSOR PORTS

The following table lists the ports used by the CS 50 Sensor for communication.

Port Number	Protocol	Name
49059	TCP	RPC
49049	TCP	I/O
49050	TCP	PIC/LIVE
49200	TCP	REPORT
49202	TCP	REPORT/CONTROL
49201	TCP	PARTQ
49079	TCP	KEEPALIVE
49211	TCP	Serial TCP#1
49212	TCP	Serial TCP#2
49213	TCP	Serial TCP#3
49214	TCP	Serial TCP#4
49497	UDP	UDP BROADCAST
49496	UDP	UDP COMMAND
21	UDP	FTP
23	UDP	TELNET
80	UDP	HTTP

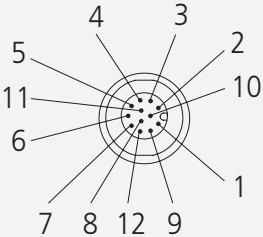
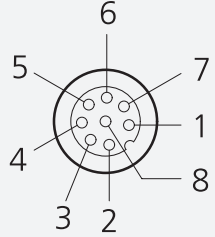
	Plug M12, 12-poled		Socket M12, 8-poled
			
PIN	Port A: Power I/O	Wire color	Port B: Ethernet
1	Trigger	brown	V (+)
2	Power	blue	V (-)
3	Not used	white	V (-)
4	Not used	green	TX (-)
5	Output 1	pink	RX (+)
6	Output 3	yellow	TX (+)
7	Ground	black	V (+)
8	Input common	grey	RX (-)
9	Host RxD	red	-
10	Host RxD	violet	-
11	Output 2	grey/pink	-
12	Output common	red/blue	-

THE FIRST STEPS

Adjust CS 50 Sensor Settings

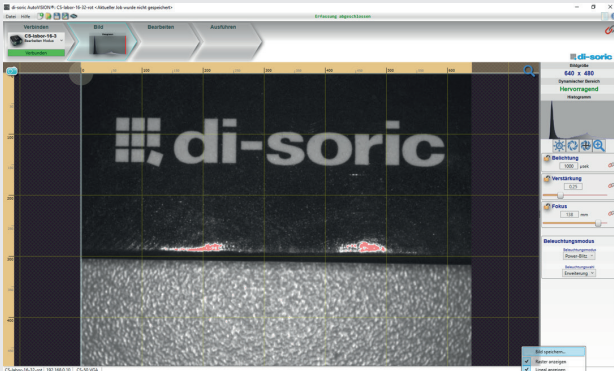

Once you have selected your CS 50 Sensor or the Emulator and created a new job, you will move to the Image view. This view allows you to Auto Calibrate the CS 50, and to manually adjust the CS 50's Exposure, Gain, and Focus, and also to set the Lighting Mode (On, Off, or Strobe). Note: If you load a job from your PC or upload a job from the CS 50, you will automatically move to the Edit view.

You can return to the Connect view and click the Modify button to adjust additional CS 50 settings, such as TCP/IP settings, Industrial Protocol settings, RS-232 settings, Ethernet settings, and CS 50 Software button settings. You can also rename your CS 50 (alphanumeric characters only - [0-9], [a-z], and [A-Z]). Click the Apply button when you have adjusted the CS 50's settings as needed.

Edit the Job

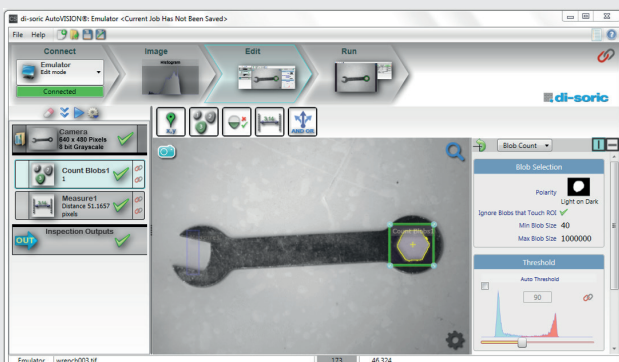

After you have created a new job, loaded a job from your PC, or uploaded a job from the CS 50, you will proceed to the Edit view to refine your machine vision job.

The Camera parameters allow you to set Gain, Exposure, Focus, Trigger, and Lighting.

Inspection Outputs options and di-soric Link functionality allow you to connect your job to the outside world.

This is also the view where you can add multiple tools to the job. The tool icons are located above the main view area.



When a tool is selected, it appears in the job list area to the left of the main view.

Run the Job



Going to the Run view will automatically download your job to the CS 50 and start it running.

The Run view provides the following feedback:

- Image Display: Displays runtime images with Tool graphics;
- Inspection Counts: Displays the number of parts inspected, passed and rejected;
- Inspection Timing Statistics: Displays statistics on the speed of your inspection;
- Tool Results: Shows the Pass/Fail status and inspection data from each of your Tools.

The following options are provided:

- Adjust the speed of the image display;
- Enable/disable graphics display;
- Save uploaded images to the PC;
- Clear the inspection counts.

Save the Job



Click the Save icon to save the job to the smart CS 50's flash memory.

Note: The Save icon shows a popup menu of jobs, allowing you to overwrite existing jobs or to create a new job.

1. Click the Stop icon.
2. Click the Save icon.
3. Click the Run icon to start again.

Note that jobs that are configured to run on stored images, saved, and then opened on a CS 50, will have their snapshot setting changed to Acquire.

PERFORMANCE THAT CAN BE SEEN. THE CS 50 FEATURES.

TOP PERFORMANCE FOR NUMEROUS APPLICATIONS.

Vision Sensor CS 50 – the world's smallest Vision Sensor offers powerful performance with easy handling for numerous verification tasks in the area of industrial application – the very best performance for completeness checks, rotation verifications, presence checks, counting objects and much more.

Up to 300% faster PERFORMANCE

The CS 50 offers a significant increase in speed compared to the existing vision sensors. A process speed with up to 2,500 component inspections per minute is possible.

THE WORLD'S SMALLEST industrial vision sensor

The CS 50 is the world's smallest Vision Sensor – this also means it can be integrated easily into machines and systems that have limited space.

EASY & INTUITIVE

Our new CS Vision Software can be operated by every sensor user – for everyone who wants to run their applications intuitively with a robust and powerful product.



Standard INTER-FACES on board

In addition to our PROFINET and RS232 standard protocols, the CS 50 is also able to communicate with your industrial environment via Ethernet IP and TCP IP.

CLICK-ZOOM & Liquid Lens Autofocus

Digitally adjusting the focal length and the Liquid Lens Autofocus option when changing a lens does not require the use of hardware and prevents misalignment.

1.4 GB of free memory

With approximately 1.4 GB of RAM, there is enough space for practically an unlimited amount of jobs.

di-soric LINK for PLC-compliant communication

As the sole producer, we supply PLC-compliant data formats for a fast, convenient connection to your PLC. This makes it possible to control the parameters in a job via external systems using a direct connection to your machine control system.

AS EASY TO USE AS A SENSOR. THE CS 50 TOOLS.

EFFICIENT TOOLS FOR A VARIETY OF TASKS.

The 5 integrated tools make it possible to efficiently, quickly and practically implement your verification tasks. The values are linked logically and can be exported explicitly as pixel values or statistical values. The individual tasks are intuitively designed and can be set up and implemented easily.



LOCATE

The Locate tool dynamically finds an unlimited amount of samples within a freely selectable image section – simultaneously.

- It teaches in an edge-, shape- and blob-based sample.
- Determines the values for the X, Y and rotation coordinates of an edge pattern.
- Determines the coordinates for tracking other tools.

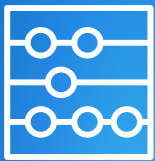

COUNT

The Count tool counts the number of particular objects within a search window. It counts objects that have been taught into an image and is ideal for checking the correct number of parts within a work-piece carrier.

- Tests the correct number of holes within a part.
- Finds and determines the number of objects within an image.

The Count tool can count blobs as well as outlines.



PRESENCE

The Presence tool detects the presence/absence of a feature based on pixel values/contrast.

- Counts the number of pixels within an intensity field from 0 to 255.
- Counts the pixels within an image using contrast transition.

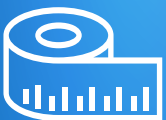

MEASURE

The Measure tool carries out pixel-based height or width measurements between edges or points. Angle- and radius-measurements can also be carried out.

- It detects two edges or points and measures the distance between them.
- It discharges measured parts outside of the user-defined limits.

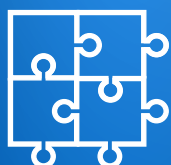

LOGIC

The Logic tool makes it possible to make connections among CS 50 boolean results simply and logically.

- The connections make it possible to combine multiple tool results and pass these along to the respective camera outputs.
- This makes it possible to carry out logical operations quickly and easily.
- Logical connections can be used on the CS 50 and without using your PLC.

CS 50 VISION SENSOR

TECHNICAL DATA



- Outstanding performance at up to 2,520 checks / minute
- Image export over FTP
- Interchangeable light, filter and polarizer
- Option of simultaneous feature detection and measurement of multiple objects
- Profinet / Ethernet / TCP-IP / RS 232
- Multilingual, intuitive software
- Part detection, presence, measurement, positioning, counting and logic



Design

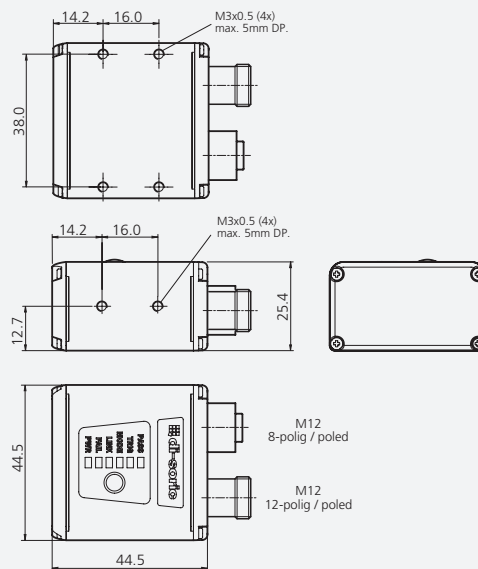

mm (typ.)

Software requirements:

Auto VISION 4.0.1 runs on the following operating systems:

- Microsoft Windows 7 (32-bit), SP1
- Microsoft Windows 7 (64-bit), SP1
- Microsoft Windows 10 (64-bit)

Important: Adobe Acrobat Reader 4.0 or higher is required for reading and printing the Visionscape documentation.

Minimum computer requirements:

- Intel® Core™ i3 Processor @1.6GHz
- Internet Explorer 11 / Google Chrome
- 2GB RAM (Windows 7 SP1 / Windows 7 Embedded Standard SP1)
- 3GB hard drive space
- 32-bit color display, 1366x768 or 1280x960
- 4.0 Windows Experience Index (particularly for graphics)
- 1 USB 2.0 port and 1 network port

Recommended computer requirements:

- Intel® Core™ i7 Processor @ 2.0GHz
- Internet Explorer 11 / Google Chrome
- 8GB RAM (Windows 7 SP1)
- 10GB of hard drive space
- 32-bit color display, 1920x1080
- 5.0 or greater Windows Experience Index
- 1 USB 2.0 port and 1 Gigabit Network port (Intel Chipset recommended)

	CS 50 BM2-2-ES-G1 BM2-2-ES-G5	CS 50 BM2-4-ES-G1 BM2-4-ES-G5	CS 50 BM2-4L-ES-G1 BM2-4L-ES-G5
Housing dimensions H/W/D	25.4 / 44.5 / 44.5 mm	25.4 / 44.5 / 44.5 mm	25.4 / 44.5 / 44.5 mm
Service voltage	5...30VDC	5...30VDC	5...30VDC
Working distance	50 – 300 mm	40 – 150 mm	75 – 1200 mm
Selectable focal length	5 mm / 10 mm	16 mm / 32 mm	16 mm / 32 mm
Internal lights	<ul style="list-style-type: none"> ■ G1: High power red ■ G5: High power white 	<ul style="list-style-type: none"> ■ G1: High power red ■ G5: High power white 	<ul style="list-style-type: none"> ■ G1: High power red ■ G5: High power white
Image output	sw/VGA	sw/VGA	sw/VGA
Tools	<ul style="list-style-type: none"> ■ Locate ■ Count ■ Presence ■ Measure ■ Logic 	<ul style="list-style-type: none"> ■ Locate ■ Count ■ Presence ■ Measure ■ Logic 	<ul style="list-style-type: none"> ■ Locate ■ Count ■ Presence ■ Measure ■ Logic
Number of jobs	Unlimited (1,4 GB)	Unlimited (1,4 GB)	Unlimited (1,4 GB)
Focusing	Electronic Autofocus	Electronic Autofocus	Electronic Autofocus
Interfaces & protocols	RS232 Ethernet-IP, TCP-IP, ProfiNet	RS232 Ethernet-IP, TCP-IP, ProfiNet	RS232 Ethernet-IP, TCP-IP, ProfiNet
Digi I/Os	1 (Trigger)/3	1 (Trigager)/3	1 (Trigger)/3
Image storage	via FTP	via FTP	via FTP
Accessories	<ul style="list-style-type: none"> ■ Filter ■ Diffuser ■ Polarizer ■ Holder ■ Cable ■ HMI ■ Additional high power lighting 	<ul style="list-style-type: none"> ■ Filter ■ Diffuser ■ Polarizer ■ Holder ■ Cable ■ HMI ■ Additional high power lighting 	<ul style="list-style-type: none"> ■ Filter ■ Diffuser ■ Polarizer ■ Holder ■ Cable ■ HMI ■ Additional high power lighting

CS 50 VISION SENSOR

TECHNICAL DATA

Field of vision, focal length 5/10mm

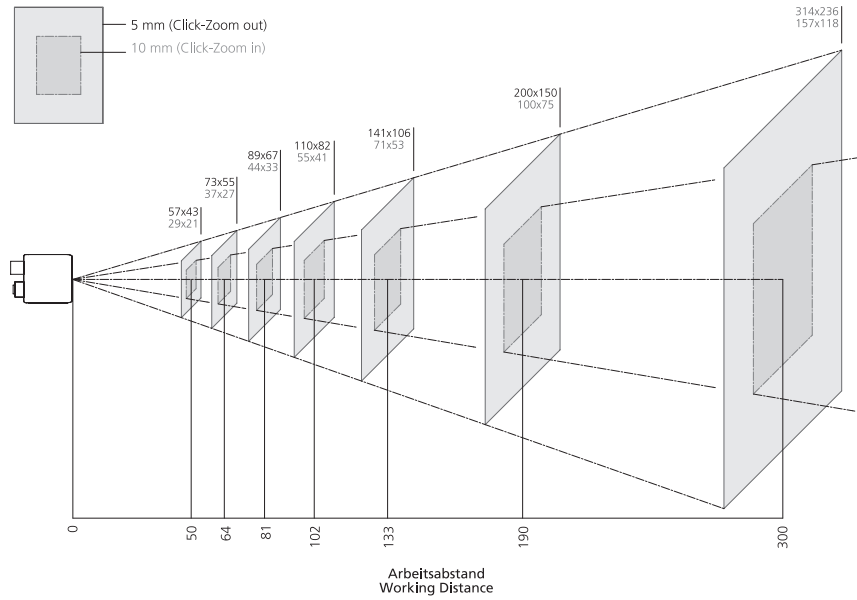

all specifications in mm

Field of vision, focal length 16/32mm

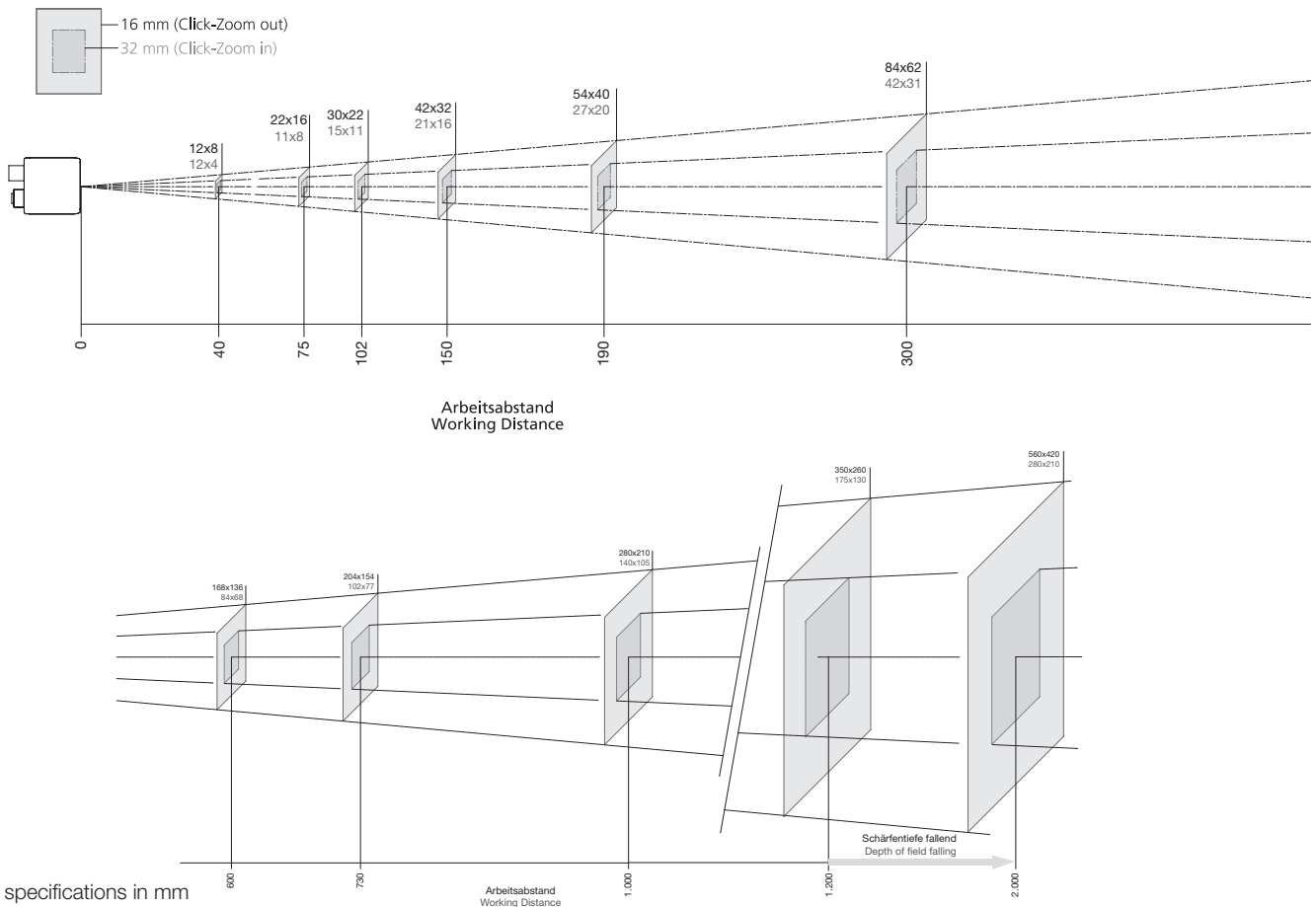

all specifications in mm

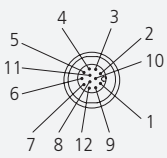
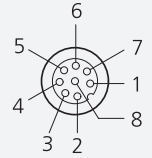
Plug M12, 12-poled			Socket M12, 8-poled	
				
PIN	Port A: Power I/O	Wire color	Port B: Ethernet	
1	Trigger	brown	V (+)	
2	Power	blue	V (-)	
3	Not used	white	V (-)	
4	Not used	green	TX (-)	
5	Ouput 1	pink	RX (+)	
6	Ouput 3	yellow	TX (+)	
7	0VDC	black	V (+)	
8	Input common	grey	RX (-)	
9	Host RxD	red	-	
10	Host TxD	viole	-	
11	Output 2	grey/pink	-	
12	Output common	red/blue	-	

Power, trigger and output wiring

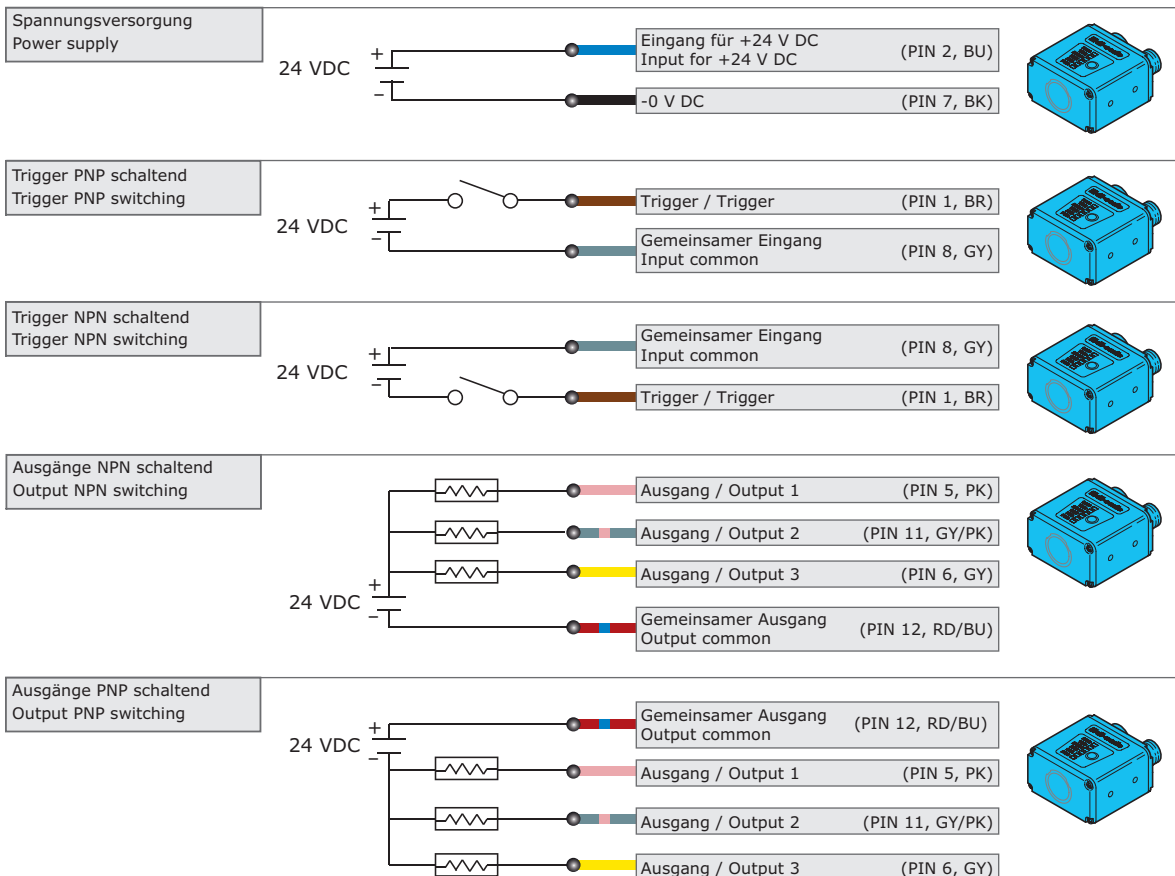

CHECKING AND UPDATING THE FIRMWARE

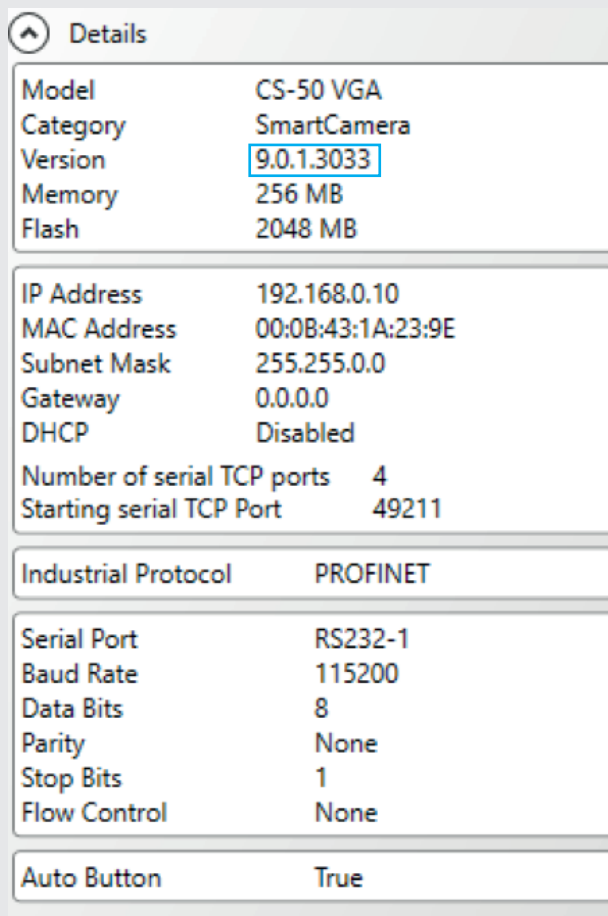
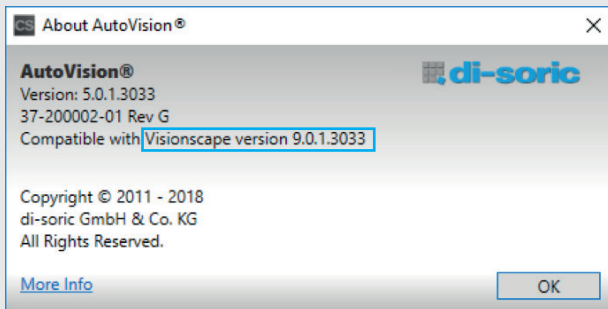

- Ensure that the device firmware corresponds to the software version.
- Option to check using AutoVision: “Help > About AutoVision”

- The version must always correspond to the camera firmware under Details (see picture on the left).

If the firmware does not match, the firmware must be updated. Use the firmware update tool that is installed as part of the AutoVision installation. Open the tool:

Device firmware update

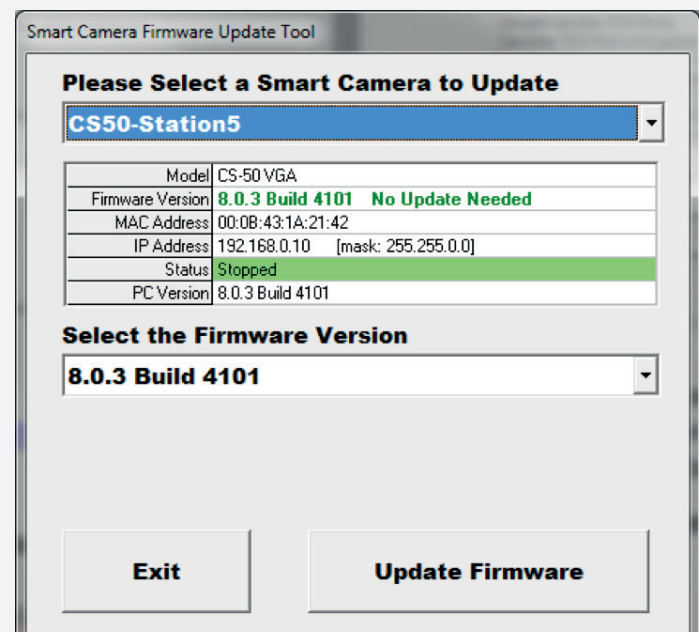

The following describes a firmware update:

- Throughout the process, ensure that a proper power supply is maintained. Interrupting the power supply during the firmware update may result in damage to the device. Repairs may only be carried out by di-soric.
- An additional requirement is a stable network connection, preferably with a static IP address.

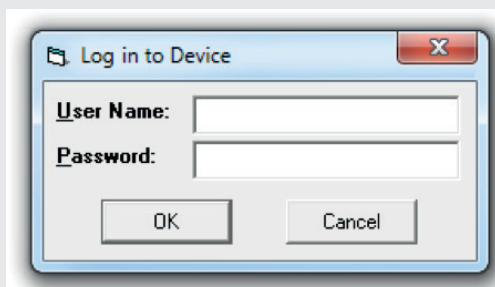
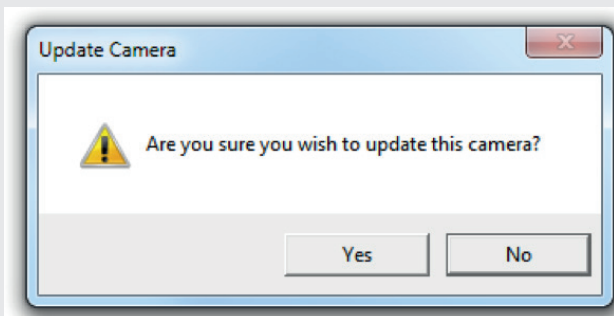

CS 50 Software's simple Device Firmware Update feature makes it easy to download and install firmware on your CS 50.

To download and install firmware:

- Navigate to Windows "Start Menu > Programs > di-soric CS 50 Software > Device Firmware Update".
- After you click Device Firmware Update, the Firmware Update Tool will appear. Select your CS 50 from the Please Select a Camera to Update dropdown menu.
- Note: Only CS 50 on the same network as your PC will be visible in this menu.
- Once you have selected your CS 50, its identifying details, such as Model, Firmware Version, MAC Address, IP Address, Status, and PC Version will be displayed.
- Select the desired version of firmware from the dropdown menu. This menu will list all the firmware versions on your PC.

Note: The firmware versions shown below are representative examples and may not necessarily reflect what you see on the dropdown menu.

- Click the Update Firmware button.
- A dialog will appear asking Are you sure you wish to update this camera? Click Yes.
- If a username and password have been defined for the CS 50, a second dialog will then appear prompting you for your username and password.
- Important: The user name and password are both case-sensitive. Click OK after you have entered your user name and password to begin the download and install process. The firmware update process may take more than a minute. Once the firmware is downloaded and installed, the CS 50 will reboot.
- When the entire firmware update process is complete, click the Exit button to close the utility.

PART 2 OF THE QUICK START INSTRUCTIONS

TROUBLESHOOTING

- **CS 50 is not visible in AutoVision under “Connect”**

Possible cause: Ports have been blocked, specifically the UDP Port 49497 for the broadcast.

- **The CS 50 was being operated on a Profinet PLC, the connection to the PLC was disconnected and the CS 50 is no longer visible in the network.**

Possible cause: The CS 50 is waiting for the PLC communication. Without the PLC as a master, it does not have a valid IP address in the network. There are two possible solutions.

1. The network connection to the PLC is reestablished and the CS 50 obtains another valid IP address over the PLC.
2. The user waits through a 5 min timeout and then the CS 50 reappears in the network under a DHCP address.

At this point, a static IP should be assigned.

- **The device name does not change in AutoVision, although a Profinet name has been assigned over Profinet.**

Cause: According to the most recent standards, the Profinet name and the device name are independent and may differ.

- **The IP address and subnet mask cannot be changed.**

Possible cause: The computer features a second network card. Please deactivate it in Windows/Network Adapters.

- **The job on the CS 50 does not have a name. It is just called “Job 1” or “Job 2”, etc. How do you change this?**

Cause: The jobs must be saved and named on the computer before AutoVision is able to determine which names should be assigned to the job slots.

- **After a job change (through Profinet or manually), the software does not have a job loaded.**

Cause: AutoVision shows only the names of jobs that are active, i.e. being processed. Once a job change has been made, the job is no longer active in AutoVision and instead is only stored in the CS 50 camera.

- **Job change not possible over Profinet; trigger functioning.**

Cause: The user is connected to the CS 50 over AutoVision in parallel to the PLC and has made changes. This means that the connection to the CS 50 is occupied by AutoVision. Please disconnect the connection to AutoVision. It is possible to use AutoVision to view information, but interacting with AutoVision will cause it to take control again. Examples of such interaction would be sending a trigger over AutoVision or selecting a job change.

- **Help does not open. The F1 key is not functioning.**

Possible cause: The German Help was not installed properly. The file can be downloaded at the following link:

https://www.di-soric.com/en/Vision-sensor-CS-50-di-soric-59772.html?pdb_kategorie=105853

Another solution could be: update the newest Version of Autovision.

- **AutoVision cannot be installed or will not start after installation.**

Possible cause: The user does not have all rights necessary for installing software (administrative rights). Win8 or 8.1 must be installed and run under Win7 compatibility mode. After installation, not all drivers or registrations were successful in Windows. You can run another installation or software repair. If that does not help either, please contact di-soric Support.

■ **AutoVision has been installed. Communication with the CS 50 is not possible or is possible with limitations.**

Possible cause: The following ports are required for complete communication and function of all CS 50 devices and may not be closed by firewalls or other anti-virus software. In the event of malfunctions, please get in touch with your IT department and keep the following list available for enabling or checking ports.

The following table lists the ports used by the CS 50 Sensor for communication.

Port Number	Protocol	Name
49059	TCP	RPC
49049	TCP	I/O
49050	TCP	PIC/LIVE
49200	TCP	REPORT
49202	TCP	REPORT/CONTROL
49201	TCP	PARTQ
49079	TCP	KEEPALIVE
49211	TCP	Serial TCP#1
49212	TCP	Serial TCP#2
49213	TCP	Serial TCP#3
49214	TCP	Serial TCP#4
49497	UDP	UDP BROADCAST
49496	UDP	UDP COMMAND
21	UDP	FTP
23	UDP	TELNET
80	UDP	HTTP

PART 2 OF THE QUICK START INSTRUCTIONS

TROUBLESHOOTING

■ Despite ports being enabled for AutoVision, the device is still not visible in the network.

Possible solution: Adding a new firewall rule that generally allows communication for all programs over the required ports. The following procedure is required for a new firewall rule:

- Control Panel\System and Security\Windows Firewall
- Left-click “Advanced Settings”
- Then left-click “Inbound Rules” and add a new rule.

(You can create all TCP or UDP ports in one entry. To do so, separate the ports with commas. Of course, IT knows exactly how to do this already—they would just need to be told that it is necessary).

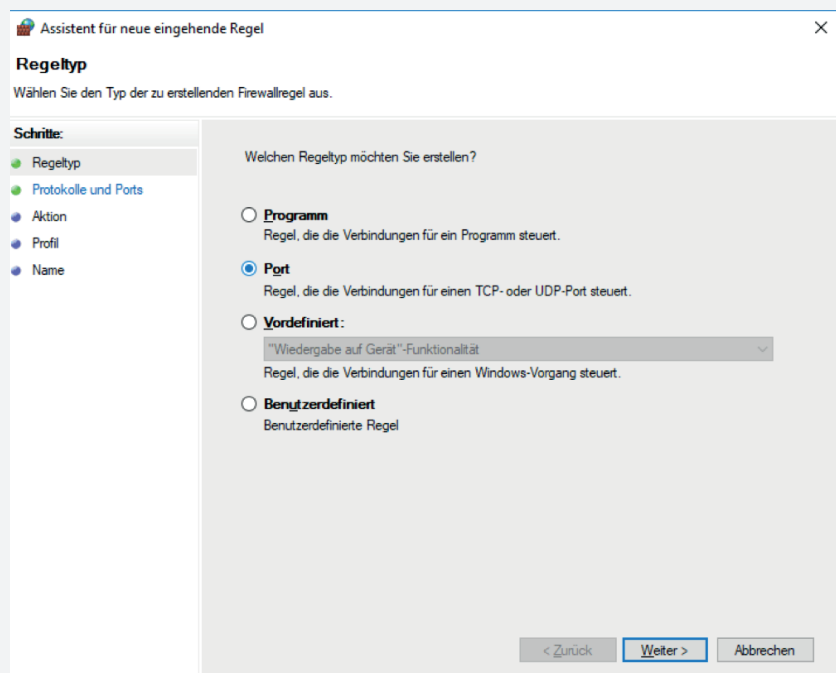
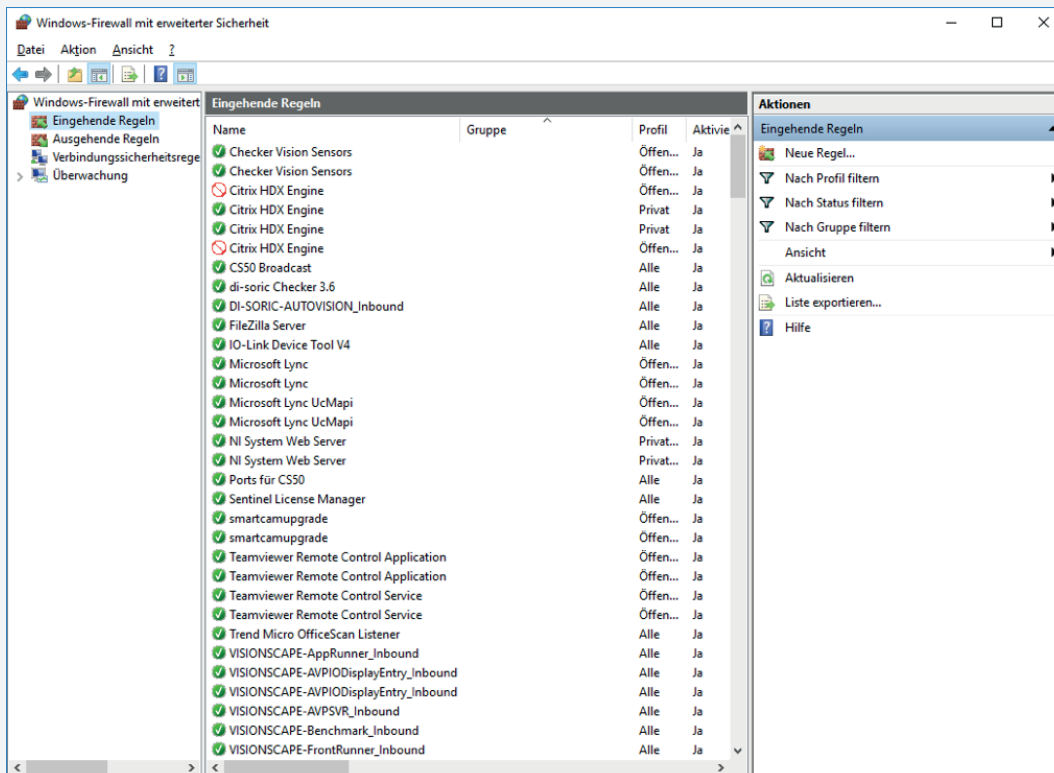

The customer may need to start using the CS 50 before IT has enabled the necessary ports. In this case, a quick, short-term solution can be configured in order to make the CS 50 visible in the network.

Provided that the IP address is known, you can go to the Network Overview tool that is always included in the AutoVision installation and click the “Add Device by IP” button to add the IP address of the CS 50. Save it by clicking “Save and Exit.”

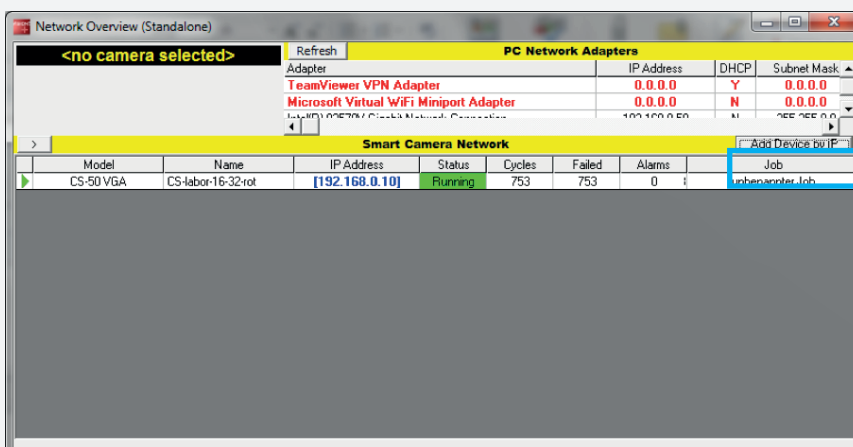
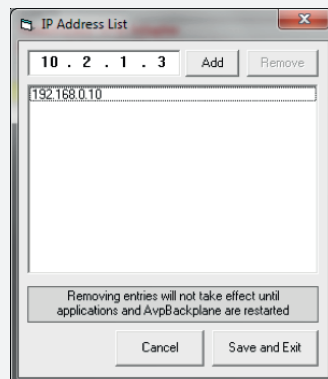
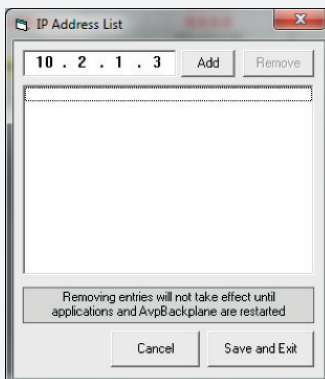
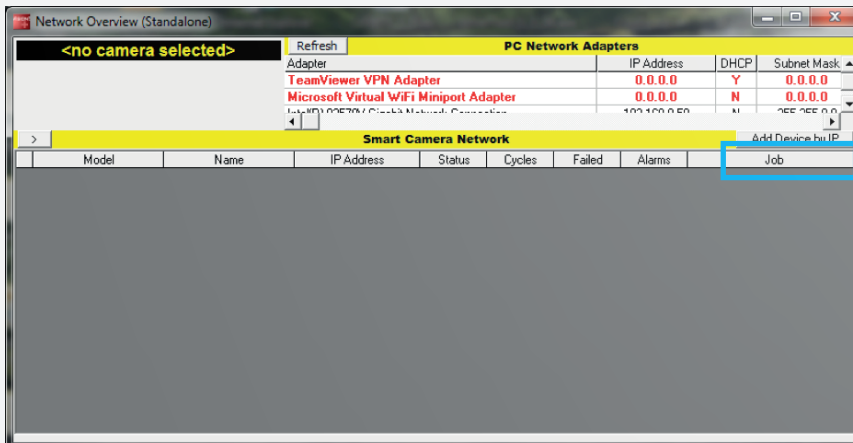

After this, the CS 50 is visible and the IP address appears in blue text, indicating that it has been added manually. This function is also helpful if you want to recognize or view the CS 50 over multiple subnetworks. The traditional setup involves a system network separate from the maintenance network. Although these networks have an internal router connection, AutoVision does not receive the broadcast it must receive in order to recognize the CS 50. In this case, using “Add Device by IP” is the only solution.

SOLUTIONS. CLEVER. PRACTICAL.

**di-soric
GmbH & Co. KG**

Steinbeisstrasse 6
73660 Urbach
Germany

Phone: +49 71 81 98 79-0
Fax: +49 71 81 98 79-179

info@di-soric.com
www.di-soric.com

**di-soric
International**

di-soric GmbH & Co. KG | Germany
di-soric Austria GmbH & Co. KG | Austria
di-soric SAS | France
di-soric Pte. Ltd. | Singapore

www.di-soric.com/international