

VKHM-Z/VSM-Z/I

Funktionsadapter
Function adapters
Adaptateurs multifonctions

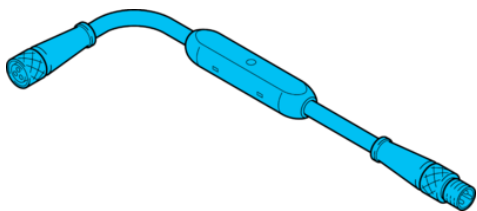

di-soric GmbH & Co. KG
Steinbeisstraße 6
DE-73660 Urbach
Germany
Tel: +49 (0) 7181/9879-0
info@di-soric.com · www.di-soric.com

202854

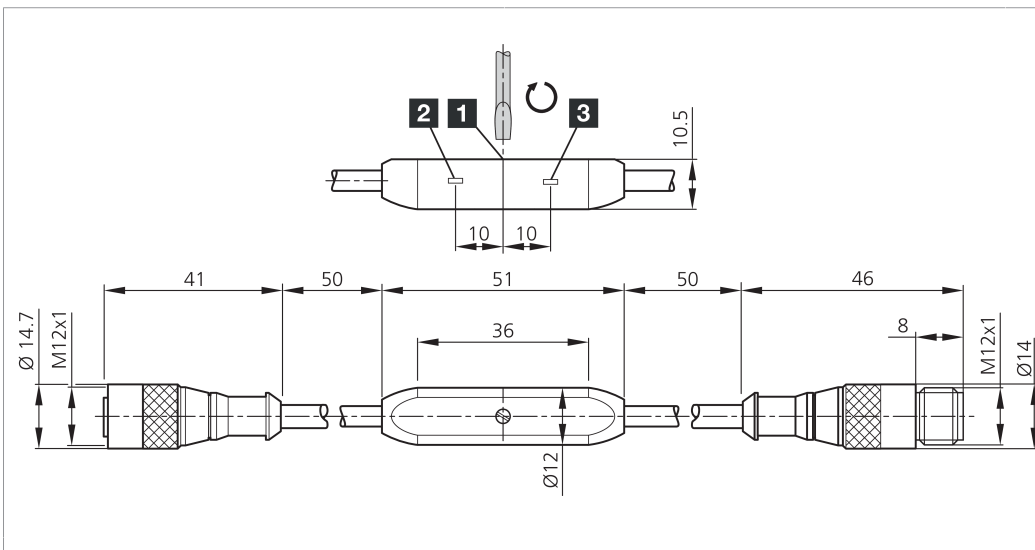

1) Potentiometer (nur ...TSM-Z/T) / Potentiometer (only ...TSM-Z/T) / Potentiomètre (uniquement ...TSM-Z/T)
2) LED STATUS / LED STATUS / LED STATUT
3) LED SCHALTAUSGANG / LED SWITCHING OUTPUT / LED SORTIE DE COMMUTATION

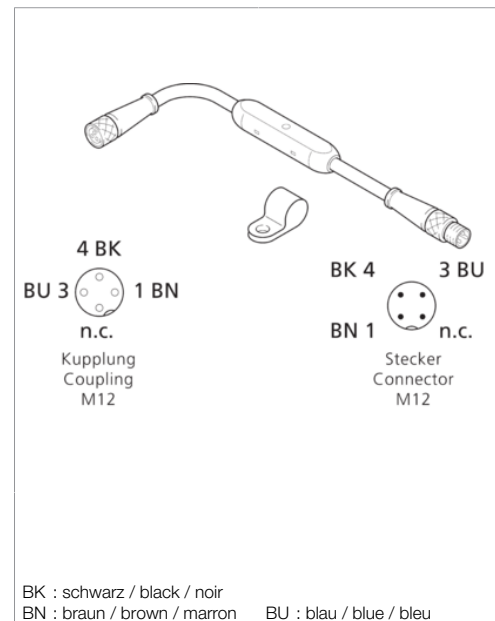

BK : schwarz / black / noir
BN : braun / brown / marron BU : blau / blue / bleu

Technische Daten	Technical data	Caractéristiques techniques	+20°C, 24 V DC
Auswertung	Evaluation	Évaluation	pnp Invertierer / pnp inverter / Inverseur pnp
Betriebsspannung	Service voltage	Tension de service	10 ... 35 V DC
Leerlaufstrom (max.)	No-load current (max.)	Courant de marche à vide (max.)	20 mA
Funktionsauswahl	Function selection	Sélection de fonctions	pnp
Schaltfrequenz	Switching frequency	Fréquence de commutation	3500 Hz
Umgebungstemperatur Betrieb	Ambient temperature during operation	Température ambiante de fonctionnement	-20 ... +70 °C
Schutzart	Protection type	Indice de protection	IP 67
Anschluss 1	Connection 1	Raccordement 1	Pigtail Kupplung, M12, 3-polig / Pigtail Coupling, M12, 3-pin / Pigtail Couplage, M12, 3 pôles
Anschluss 2	Connection 2	Raccordement 2	Pigtail Stecker M12, 3-polig / Pigtail Connector M12, 3-pin / Pigtail Connecteur M12, 3 pôles

Stand 16.07.24, Änderungen vorbehalten
As of 07/16/24, subject to change
État 16.07.24, sous réserve de modifications



Sicherheitshinweise	Safety instructions	Consignes de sécurité
Allgemeiner Sicherheitshinweis WARNUNG! Kein Sicherheitsbauteil gemäß 2006/42/EG und EN 61496-1/-2! Darf nicht zum Personenschutz eingesetzt werden! Nichtbeachtung kann zu Tod oder schwersten Verletzungen führen! Nur bestimmungsgemäß verwenden!	General safety notice WARNING! Not a safety component pursuant to 2006/42/EG and EN 61496-1/-2! May not be used for personal protection! Non-compliance can lead to death or serious injuries! Only use as directed!	Consigne de sécurité générale AVERTISSEMENT ! Ce produit n'est pas un composant de sécurité au sens des réglementations 2006/42/CE et NF EN 61496-1/-2 ! Ne pas l'utiliser pour la protection des personnes ! Le non-respect de cette consigne peut entraîner la mort ou des blessures graves ! N'utiliser le produit que selon son utilisation conforme !

VKHM-Z/VSM-Z/I

多功能转接器

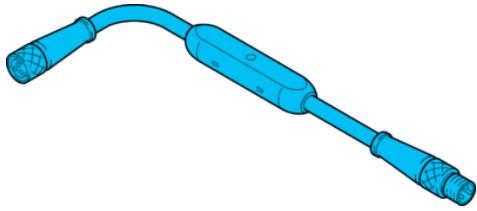

di-soric GmbH & Co. KG
Steinbeisstraße 6
DE-73660 Urbach
Germany
Tel: +49 (0) 7181/9879-0
info@di-soric.com · www.di-soric.com

202854



版本 24.07.16, 保留变更权

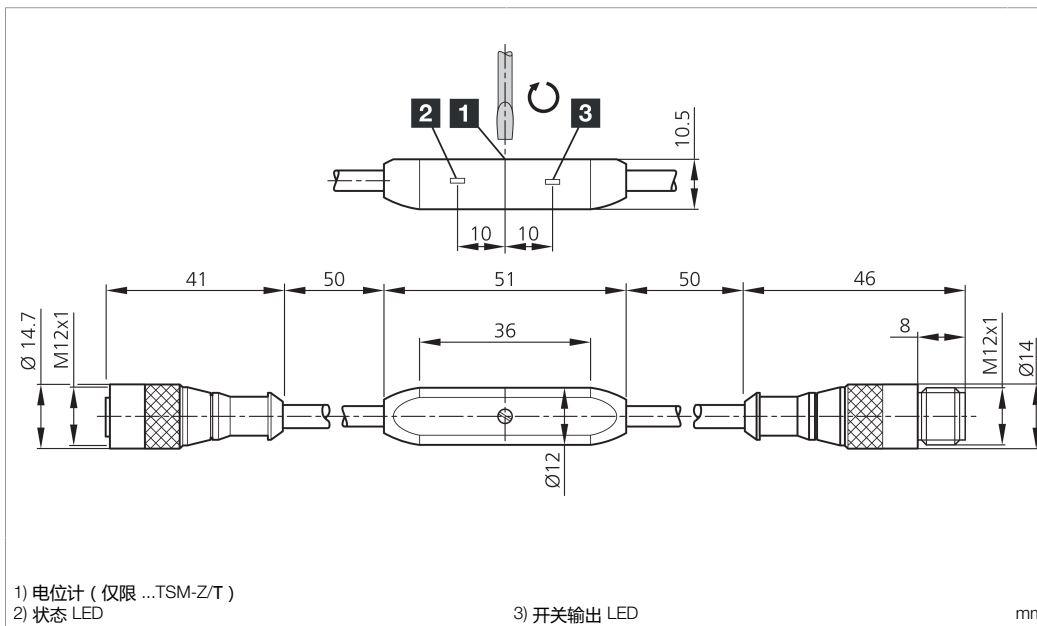

技术数据

评估

工作电压

空载电流 (最大)

功能选择

开关频率

工作环境温度

防护等级

连接 1

连接 2

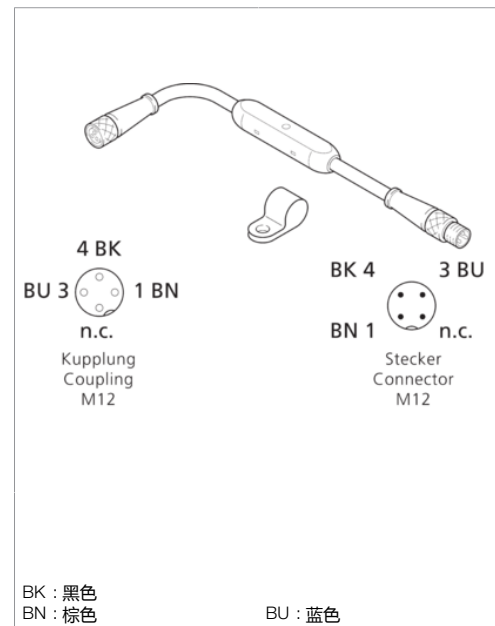

+20°C, 24 V DC

pnp 反相器

10 ... 35 V DC

20 mA

pnp

3500 Hz

-20 ... +70 °C

IP 67

电缆/插头 母头, M12, 3 针

电缆/插头 插头 M12, 3 针

安全提示



一般安全提示

警告！没有符合 2006/42/EU 和 EN 61496-1 /-2 标准的安全结构件！不得用于人身安全保护！不遵守规定会导致死亡或重伤危险！仅按规定使用！