

# SH-5-10

Sensorhalter Ø 5mm  
 Sensor holder Ø 5mm  
 Support de détecteur Ø 5 mm

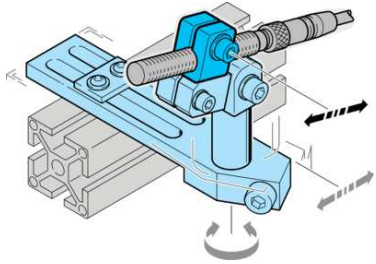

di-soric GmbH & Co. KG  
 Steinbeisstraße 6  
 DE-73660 Urbach  
 Germany  
 Tel: +49 (0) 7181/9879-0  
 info@di-soric.com · www.di-soric.com

203914

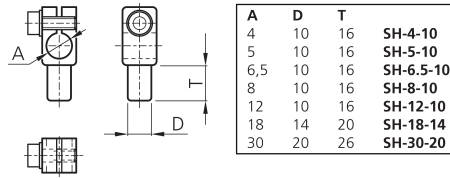

mm

Technische Daten	Technical data	Caractéristiques techniques	+20°C
Produktserie	Product series	Gamme de produits	Z-UBT-KL-PH Produkthalterung / Z-UBT-KL-PH Product bracket / Support de produit Z-UBT-KL-PH
Durchmesser A	Diameter A	Diamètre A	5 mm
Abstandsmaß D	Distance dimension D	Mesure de distance D	10 mm
Geeignet für	To be used for	Convient pour	Klemmbolzen 10 mm / Clamping pin 10 mm / Boulon de serrage 10 mm
Material	Material	Matériau	Kunststoff / Plastic / Plastique

Stand 03.11.23, Änderungen vorbehalten  
 As of 11/03/23, subject to change  
 État 03.11.23, sous réserve de modifications



**SH-5-10**

传感器支座 Ø 5mm

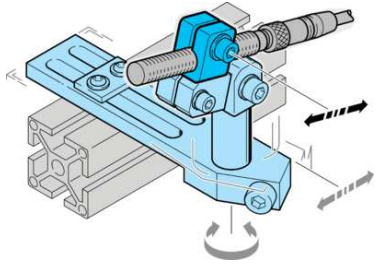

di-soric GmbH & Co. KG  
 Steinbeisstraße 6  
 DE-73660 Urbach  
 Germany  
 Tel: +49 (0) 7181/9879-0  
 info@di-soric.com · www.di-soric.com

203914

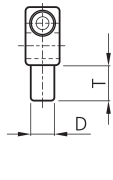
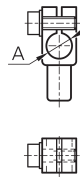

A	D	T	
4	10	16	SH-4-10
5	10	16	SH-5-10
6,5	10	16	SH-6.5-10
8	10	16	SH-8-10
12	10	16	SH-12-10
18	14	20	SH-18-14
30	20	26	SH-30-20

mm

**技术数据**

**+20°C**

产品系列

Z-UBT-KL-PH 产品支架

直径 A

5 mm

距离尺寸 D

10 mm

适合用于

夹紧螺栓 10 mm

材料

塑料

版本 23.11.03, 保留变更权

# Systemhalter Serie HS

Grundhalter Ø 12 mm

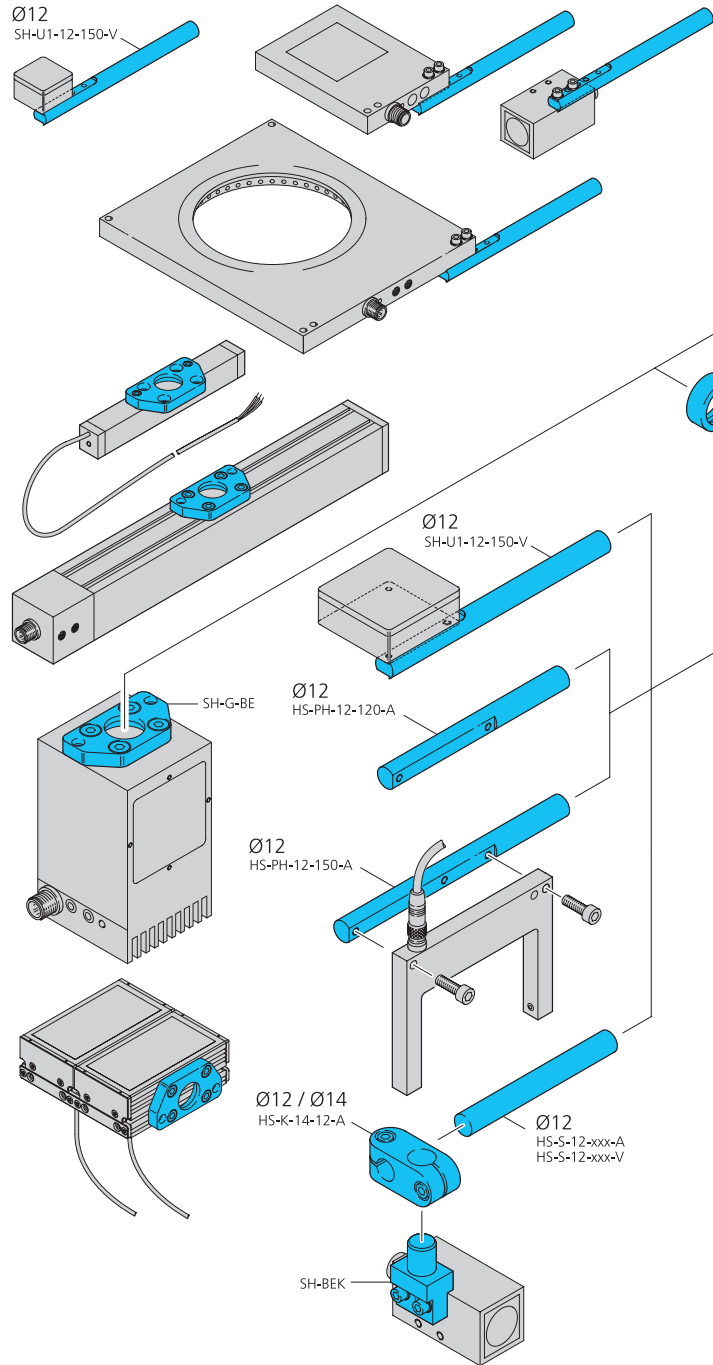

# System holder series HS

Basic system holder Ø 12 mm

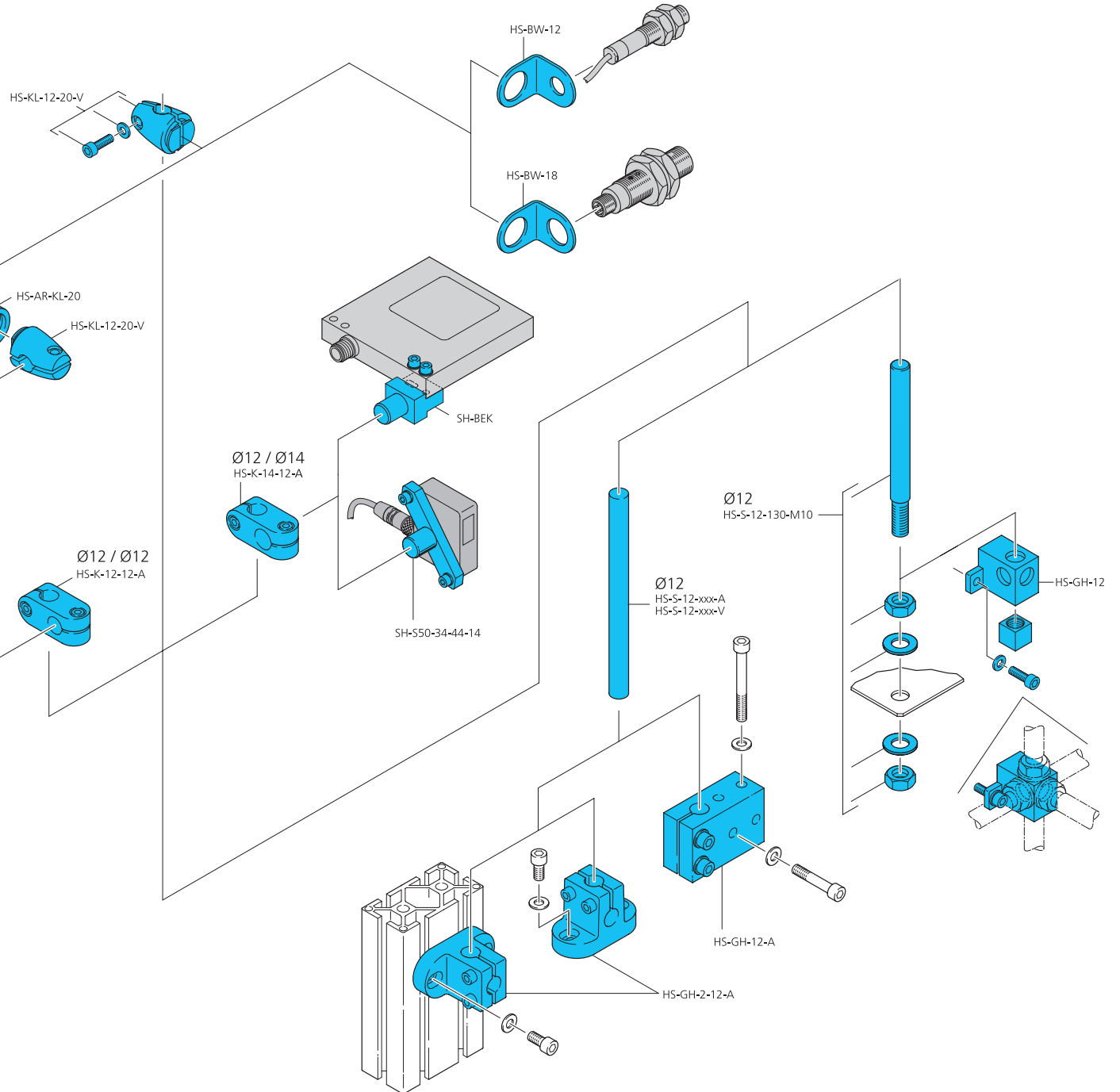

# Systèmes de fixation Série HS

12 mm du support Ø de système de base

## Systemhalter Serie HS

Grundhalter Ø 15 mm

## System holder series HS

Basic system holder Ø 15 mm

## Systèmes de fixation Série HS

15 mm du support Ø de système de base

