

# HS-K-14-12-A

Kreuzverbinder  
 Cross connector  
 Connecteur en croix

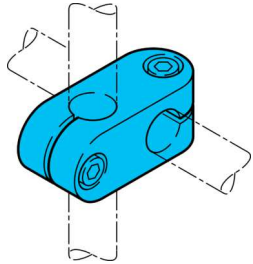

di-soric GmbH & Co. KG  
 Steinbeisstraße 6  
 DE-73660 Urbach  
 Germany  
 Tel: +49 (0) 7181/9879-0  
 info@di-soric.com · www.di-soric.com

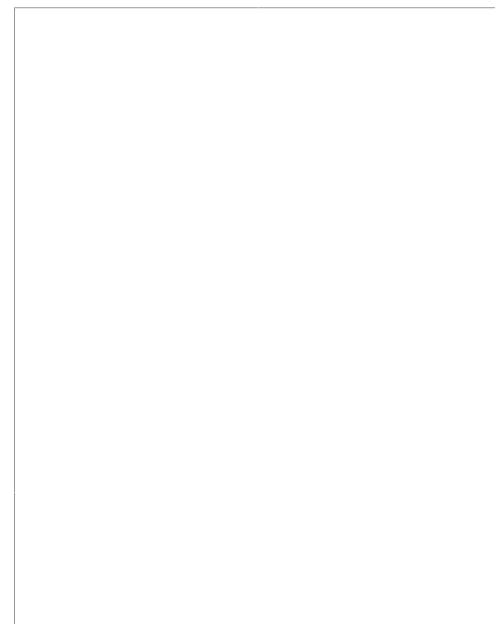
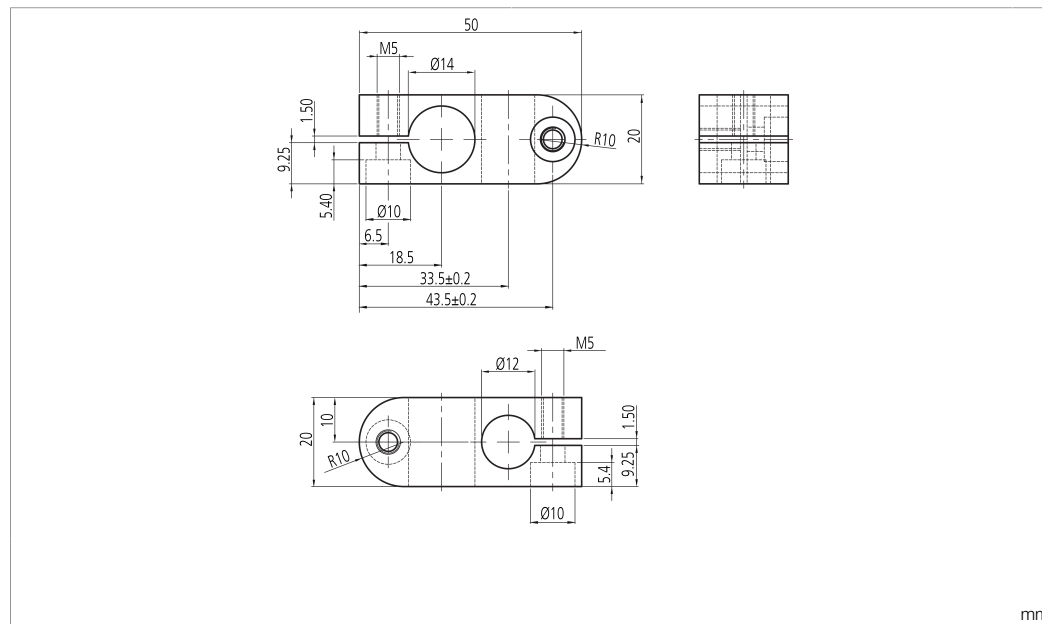

Technische Daten	Technical data	Caractéristiques techniques	+20°C
Produktserie	Product series	Gamme de produits	Z-UBT-KL-MS Montagesystem / Z-UBT-KL-MS Assembly system / Système de montage Z-UBT-KL-MS
Durchm. Montagezapfen/Bohrung	Diameter Mounting pin / boring	Diam. tourillon de montage/alésage	Ø 14 / Ø 12 mm
Material	Material	Matériau	Aluminium / Aluminum / Aluminium

Stand 03.11.23, Änderungen vorbehalten  
 As of 11/03/23, subject to change  
 État 03.11.23, sous réserve de modifications



**HS-K-14-12-A**

十字连接件

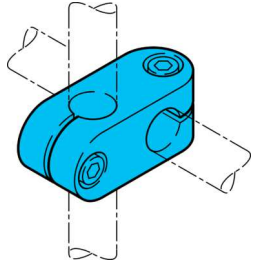

di-soric GmbH & Co. KG  
 Steinbeisstraße 6  
 DE-73660 Urbach  
 Germany  
 Tel: +49 (0) 7181/9879-0  
 info@di-soric.com · www.di-soric.com

209492

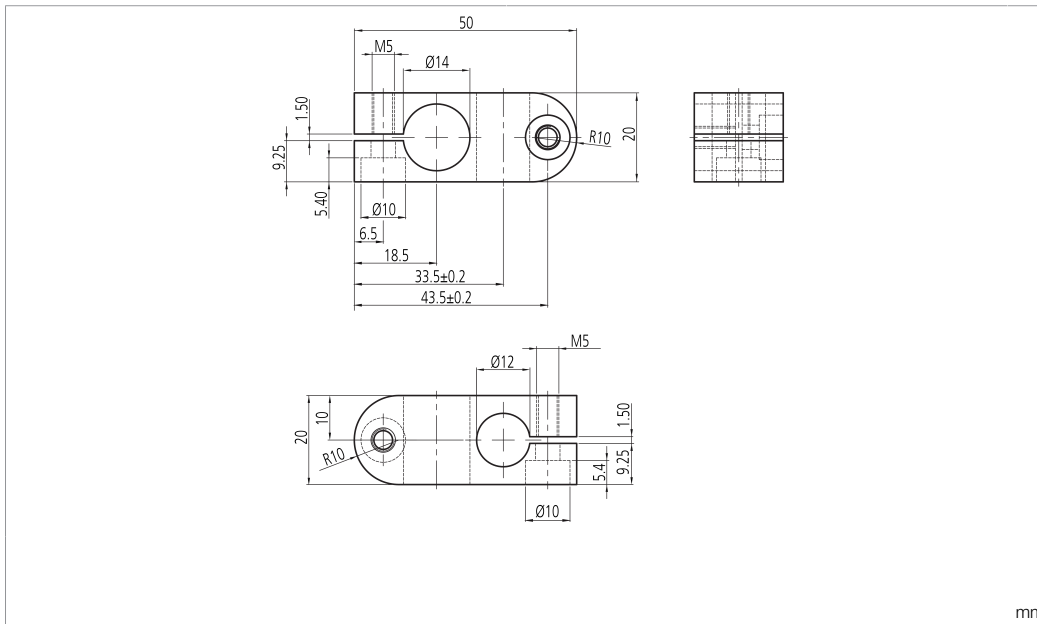

mm

<b>技术数据</b>	<b>+20°C</b>
产品系列	Z-UBT-KL-MS 安装系统
直径装配栓/钻孔	Ø 14 / Ø 12 mm
材料	铝

版本 23.11.03, 保留变更权

# Systemhalter Serie HS

Grundhalter Ø 12 mm

# System holder series HS

Basic system holder Ø 12 mm

# Systèmes de fixation Série HS

12 mm du support Ø de système de base

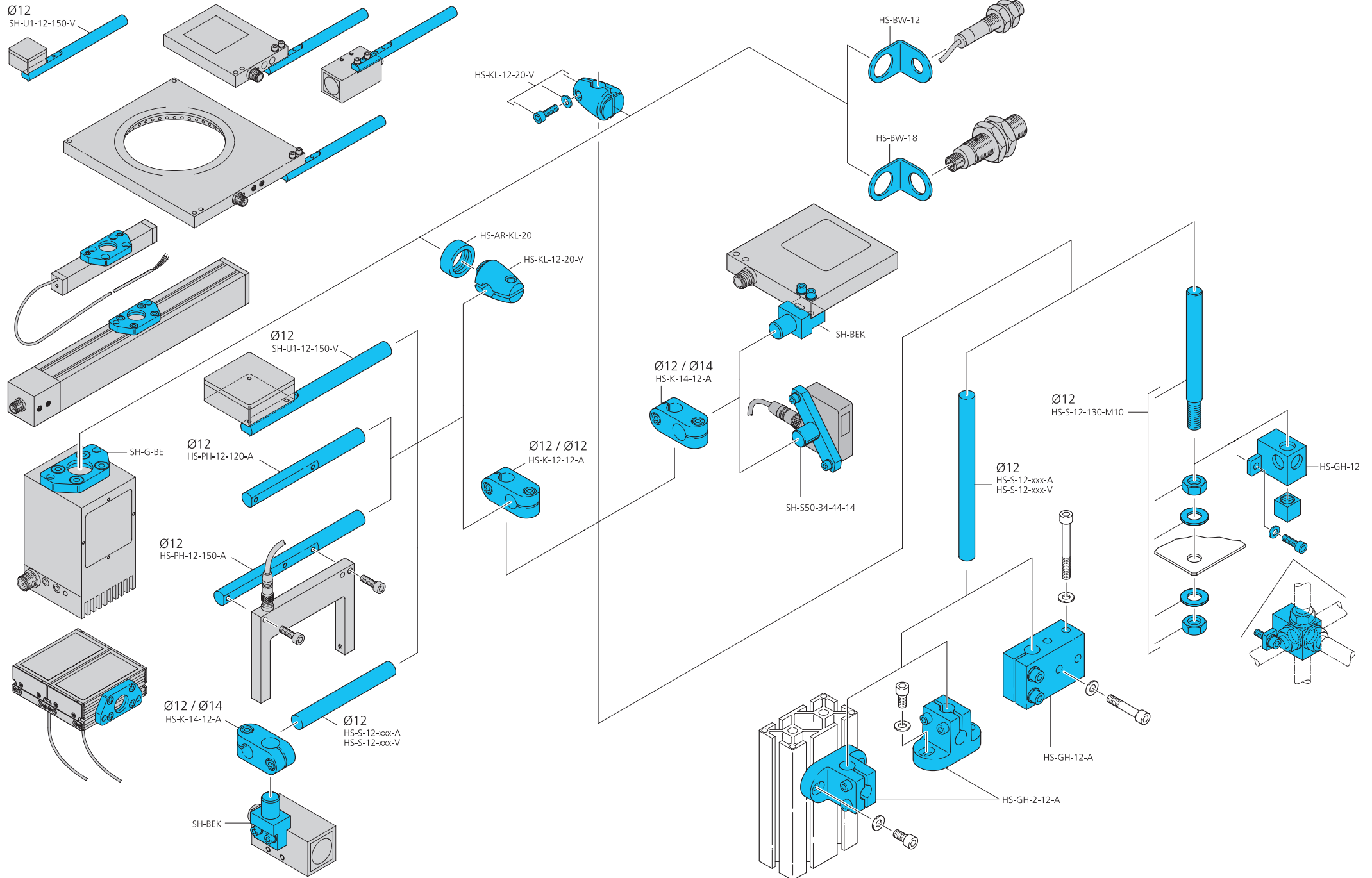

# Systemhalter Serie HS

Grundhalter Ø 15 mm

# System holder series HS

Basic system holder Ø 15 mm

# Systèmes de fixation Série HS

15 mm du support Ø de système de base

