

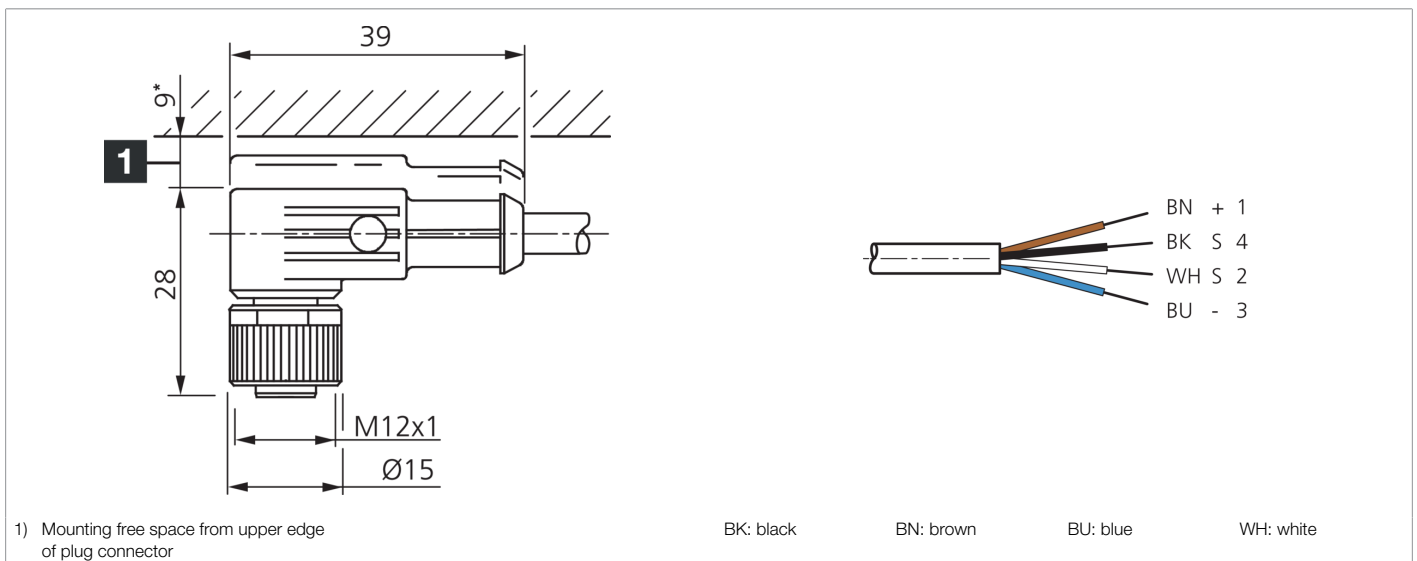

201854
VKHM-W-5/4
Connection cable

- Drag chain compatible
- Sturdy metal union nut
- Durable PU coating
- Flexible lead design
- Good stripping properties
- High protection type
- Gold-plated plug-in contacts



Function											
											  

Technical data (typ.)	
Service voltage	250 V AC/DC
Length	5,000 mm
Diameter	Ø 4.5 mm (Diameter)
Thread	M12
Material of cable	Polyurethane
Drag chain properties	45 mm (Min. bending radius)
Protection class	III, operation on protective low voltage
Design	Angled / open cable end
Characteristics	Metal nut
Drag chain compatible	Yes
LED Anzeige	No
Ambient temperature during operation	-25 ... +85 °C (Movable, Fixed)
Protection type	IP 65 / IP 66K / IP 67
Connection	Socket, M12, 4-pin, A-coded
Cross-section	0.34 mm ² (4 x)

More information / accessories <https://www.di-soric.com/201854>