

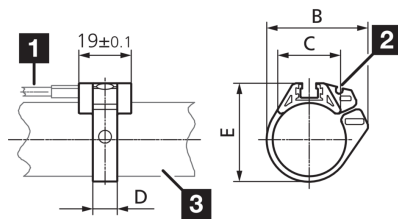

202780
MZ-S-12/6.5
Sensor clamp

- Reliable mounting of cylinder sensors at round cylinders
- High locking power
- Robust housing
- For quick and easy mounting of sensors

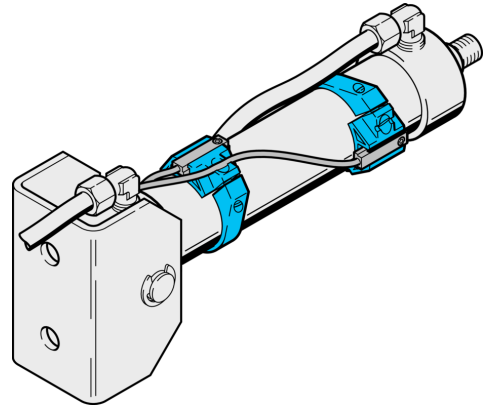

- 1) Sensor
2) Guide groove for connecting line
3) Round cylinder

Technical data (typ.)

Cylinder groove	T-groove
Assembly	at round cylinders
Distance dimension	B: 22.7 mm
Distance dimension	C: 14.3 mm
Distance dimension	D: 7 mm
Distance dimension	E: 21.9 mm
Housing material	Aluminum
Material	POM (Ring)
Component	Sensor clamp
To be used for	Ø 12 mm
Scope of delivery	Sensor holder, Fixing material

More information / accessories

<https://www.di-soric.com/202780>