

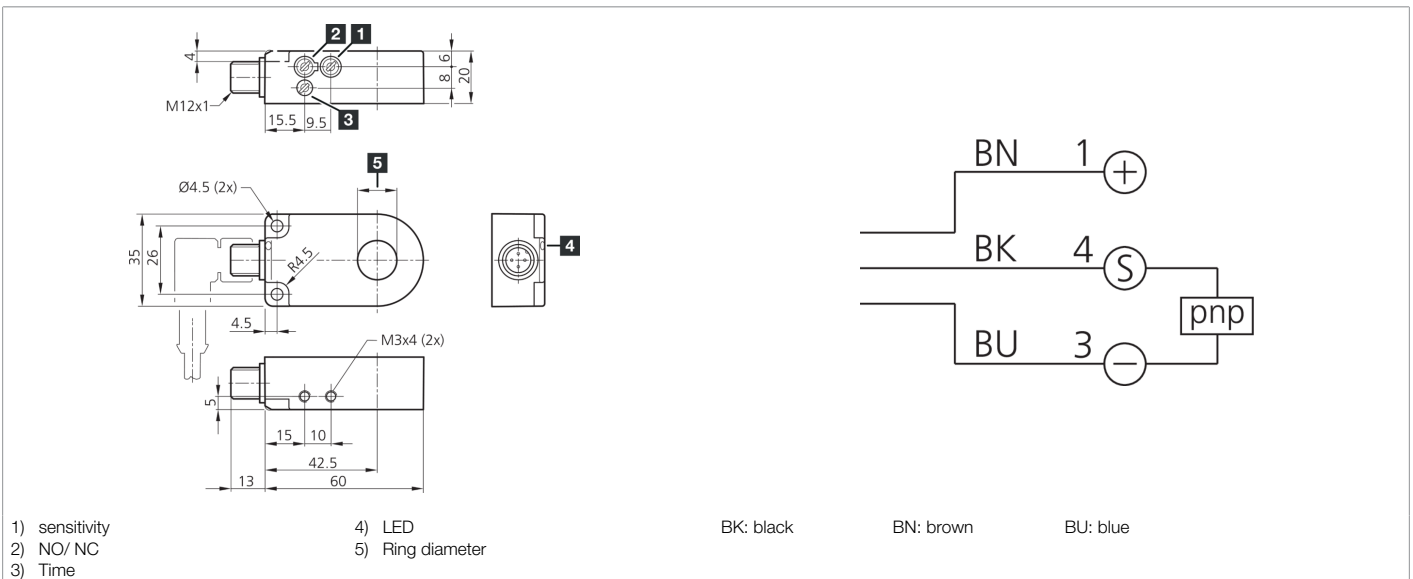

203407
IRD 25 PSOK-IBS
Inductive ring sensor

- High resolution
- Short response time
- Sensitivity and pulse stretching adjustable
- Resistant to dirt
- Dynamic operating principle
- Metal connector
- High protection type



Function													

Technical data (typ.)	+20°C, 24 V DC
Service voltage	10 ... 35 V DC (Supply Class 2)
No-load current (max.)	20 mA
Insulation voltage endurance	1000 V
Internal diameter	25.1 mm
Assembly distance to metal (min.)	5 mm
Housing material	Plastic (PA)
Material	POM (Ring)
Protection class	III, operation on protective low voltage
Approvals	UL
Operating principle	inductive
Evaluation	Dynamic
Switching output	pnp, 200 mA, NO/NC, switchable
Voltage drop (max.)	2 V
Pulse stretching	0.1 ... 150 ms adjustable
Resolution	Ø 1.2 mm
Sensitivity adjustment	Potentiometer
Speed of parts (max.)	35 m/s
Speed of parts (min.)	0.1 m/s
Response time	0.20 ms



203407

IRD 25 PSOK-IBS

Inductive ring sensor

Technical data (typ.)	+20°C, 24 V DC
Release time	0.20 ms
Ambient temperature during operation	-25 ... +70 °C
Protection type	IP 67
Connection	Connector, M12, 4-pin, A-coded
Connection cable	VK ...
More information / accessories	https://www.di-soric.com/203407