

203684
IR 15 NSOK-IBS
Inductive ring sensor

- High resolution
- Short response time
- Sensitivity and pulse stretching adjustable
- Resistant to dirt
- Static operating principle
- Metal connector
- High protection type

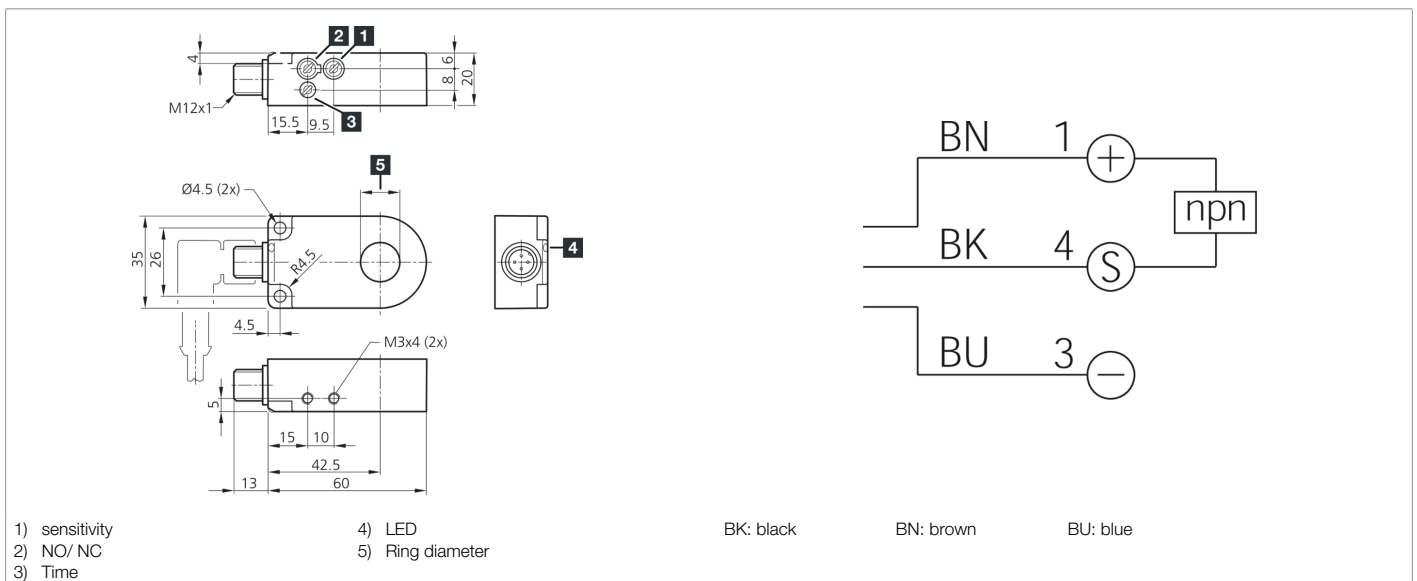

Function										

Technical data (typ.)	+20°C, 24 V DC
Service voltage	10 ... 35 V DC (Supply Class 2)
No-load current (max.)	11 mA
Insulation voltage endurance	1000 V
Internal diameter	15.1 mm
Assembly distance to metal (min.)	5 mm
Housing material	Plastic (PA)
Material	POM (Ring)
Protection class	III, operation on protective low voltage
Approvals	UL
Operating principle	inductive
Evaluation	Static
Switching output	npn, 200 mA, NO/NC, switchable
Voltage drop (max.)	2 V
Pulse stretching	10 ... 150 ms adjustable
Resolution	Ø 2.0 mm
Sensitivity adjustment	Potentiometer
Speed of parts (max.)	35 m/s
Response time	0.50 ms
Release time	10 ms



203684

IR 15 NSOK-IBS

Inductive ring sensor

Technical data (typ.)

+20°C, 24 V DC

Ambient temperature during operation

-25 ... +70 °C

Protection type

IP 67

Connection

Connector, M12, 4-pin, A-coded

Connection cable

VK ...

More information / accessories

<https://www.di-soric.com/203684>