

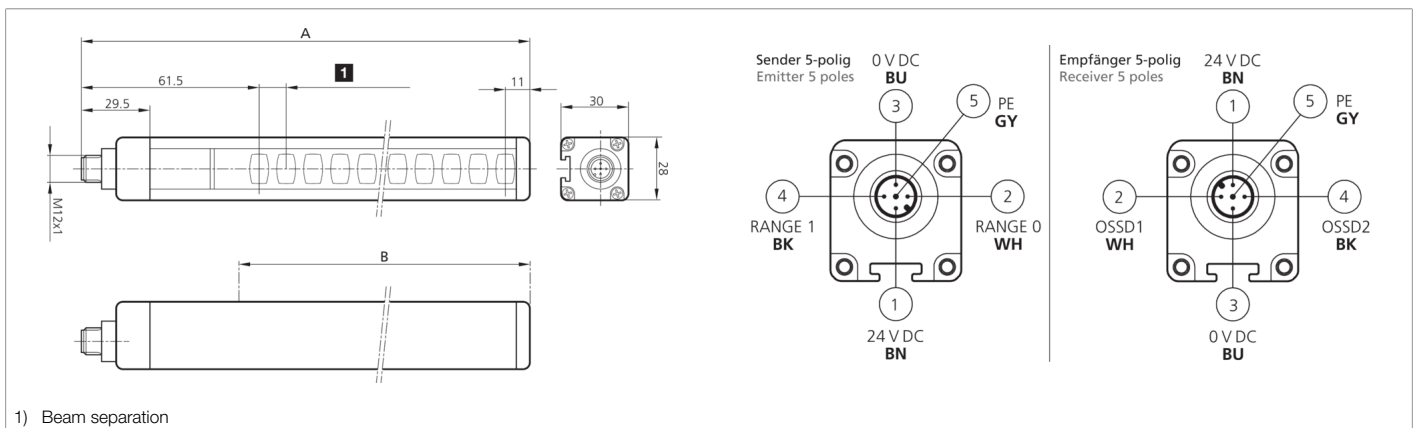

**208576**  
**SLBH4-452**  
**Safety light curtain**

- Highest safety level
- Resolution for hand protection
- Long range for large systems and applications with deflector mirrors
- Protective range to profile end
- Parameterization via connecting cable
- Easy and fast startup
- Automatic Start/Restart
- For Modular Safety Controller / safety relays
- Unshielded connecting cables up to 100 m
- High protection type



Function										

Technical data (typ.)	+20°C, 24 V DC
Service voltage	19.2 ... 28.8 V DC
Inverse polarity protection	Yes
Short-circuit protection	Yes
Total height (A)	513 mm
Mounting	T-groove (backside), / Holder SFB E 180 (optional)
Housing material	Aluminum
Material	Polycarbonate (Window)
Characteristic variables	Typ 4, Typ 4 (IEC/TS 61496-2), SIL 3 (IEC 61508), SILCL 3 (IEC 62061), PL e - Kat. 4 (EN ISO 13849-1)
Protective function	Hand protection
Protection class	III, operation on protective low voltage
Model	Basic, extended range
Start / restart	Automatic
Scope of delivery	Transmitter + receiver, one set of standard fixing brackets SA 4, CD-ROM containing the multi-language operating instructions, Quick installation guide
Safety output	pnp (2x), 400 mA / 24 V DC
Light source	LED
Color	Infrared
Wavelength	950 nm
Number of beams	45
Protective field height (B)	460 mm
Range	10000 mm (Low range) / 20000 mm (High range)
Resolution	20.0 mm

**208576****SLBH4-452****Safety light curtain**

<b>Technical data (typ.)</b>	<b>+20°C, 24 V DC</b>
Display	LED (Self-diagnosis and status of light barrier)
Reaction time	7.5 ms
Ambient temperature during operation	-20 ... +55 °C
Protection type	IP 65 / IP 67
Connection	Connector, M12, 5-pin (Transmitter)
Connection 2	Connector, M12, 5-pin (Receiver)
Cable	unshielded connection cables max. 100 m
<b>More information / accessories</b>	<b><a href="https://www.di-soric.com/208576">https://www.di-soric.com/208576</a></b>