

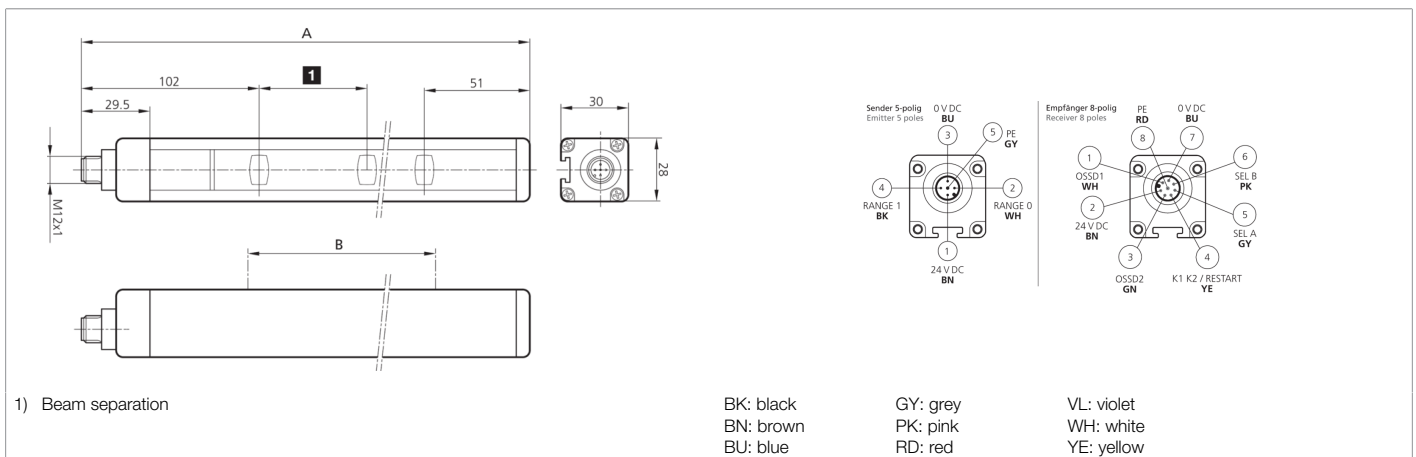

**209031**  
**SLI4-4B**  
**Safety light grid**

- Highest safety level
- Light beam interspace for access control
- Protective range to profile end
- Integrated safety function - No external safety relay required
- Parameterization via connecting cable
- Selectable manual or automatic Start/Restart
- Feedback input for external relay monitoring (EDM)
- Unshielded connecting cables up to 100 m
- High protection type



Function										

Technical data (typ.)	+20°C, 24 V DC
Service voltage	19.2 ... 28.8 V DC
Inverse polarity protection	Yes
Short-circuit protection	Yes
Total height (A)	1053 mm
Mounting	T-groove (backside), / Holder SFB E 180 (optional)
Housing material	Aluminum
Material	Polycarbonate (Window)
Characteristic variables	Typ 4, Typ 4 (IEC/TS 61496-2), SIL 3 (IEC 61508), SILCL 3 (IEC 62061), PL e - Kat. 4 (EN ISO 13849-1)
Protective function	Access control
Protection class	III, operation on protective low voltage
Model	built-in control functions (EDM)
Start / restart	Automatic / manual (selectable)
External device (relay) monitoring - EDM	Feedback input, selectable release
Scope of delivery	Transmitter + receiver, one set of standard fixing brackets SA 4, CD-ROM containing the multi-language operating instructions, Quick installation guide
Safety output	pnp (2x), 400 mA / 24 V DC
Light source	LED
Color	Infrared
Wavelength	950 nm
Beam separation	300 mm
Number of beams	4
Protective field height (B)	910 mm



209031

SLI4-4B

Safety light grid

Technical data (typ.)	+20°C, 24 V DC
Range	4000 mm (Low range) / 12000 mm (High range)
Display	LED (Self-diagnosis and status of light barrier)
Reaction time	3 ms
Ambient temperature during operation	-20 ... +55 °C
Protection type	IP 65 / IP 67
Connection	Connector, M12, 5-pin (Transmitter)
Connection 2	Connector, M12, 8-pin (Receiver)
Cable	unshielded connection cables max. 100 m
More information / accessories	<a href="https://www.di-soric.com/209031">https://www.di-soric.com/209031</a>