

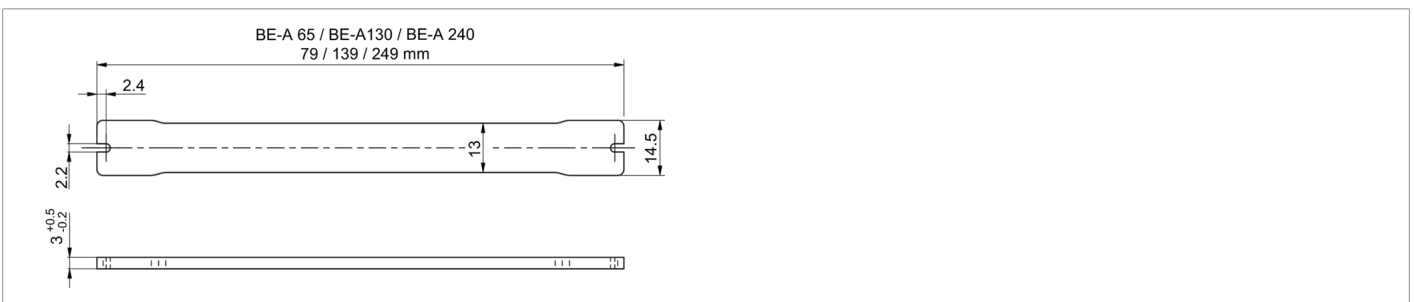

213564
BE-A240-POL
Safety screen

- Polarized protective cover
- Easily exchanged

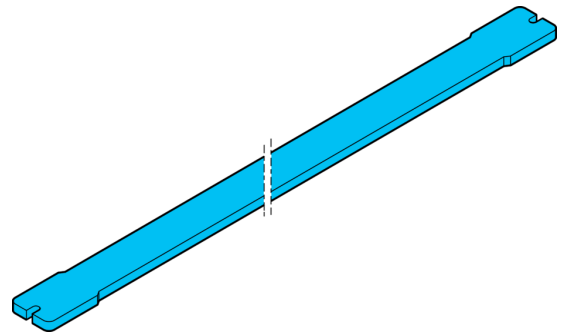

Technical data (typ.)	
Assembly	Using fixing screws
Housing dimensions	14.5 x 3 x 249 mm
Housing length	249 mm
Housing height	3 mm
Housing width	14.5 mm
Housing material	Plastic (PMMA)
Structure	PMMA base material of polarization filter laminated on with an optically clear, strapless acrylate adhesive
Weight	20 g
Component	Safety screen
Characteristics	Polarization direction is parallel to the long side
To be used for	Barlights BE-A240 ...
Operating modes	With a pulse / pause ratio of the light colors white / blue over 75%, full guarantee only with external cooling.
Scope of delivery	1 safety screen, Fixing material
Transmission	40 %
Ambient temperature during operation	0 ... +40 °C
More information / accessories	
https://www.di-soric.com/213564	