

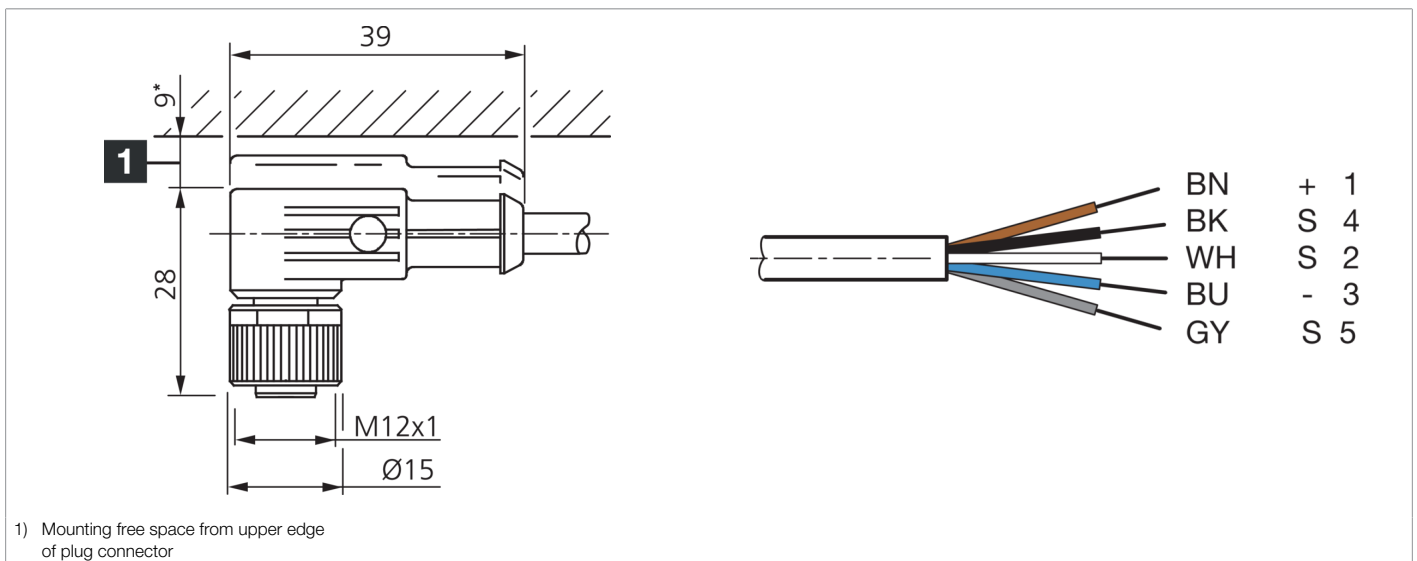



213679
VKHM-W-3/5-SB
Connection cable

- Drag chain compatible
- Sturdy metal union nut
- Durable PU coating
- Flexible lead design
- Good stripping properties
- High protection type



Function											
										CE	

Technical data (typ.)	
Service voltage	< 125 V AC/DC
Length	3,000 mm
Diameter	Ø 4.8 mm (Diameter)
Thread	M12
Material of cable	Polyurethane
Drag chain properties	48 mm (Min. bending radius)
Protection class	III, operation on protective low voltage
Design	Angled / open cable end
Characteristics	Metal nut
To be used for	SB-RGB
Drag chain compatible	Yes
LED Anzeige	No
Ambient temperature during operation	-25 ... +80 °C (Movable, Fixed)
Protection type	IP 67
Connection	Socket, M12, 5-pin, A-coded
Cross-section	0.34 mm ² (5 x)

More information / accessories
https://www.di-soric.com/213679