

SH-GLA-10-10-90

Gelenkarm
Articulated arm
Bras articulé

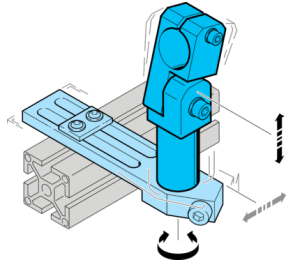

di-soric GmbH & Co. KG
Steinbeisstraße 6
DE-73660 Urbach
Germany
Tel: +49 (0) 7181/9879-0
info@di-soric.com · www.di-soric.com

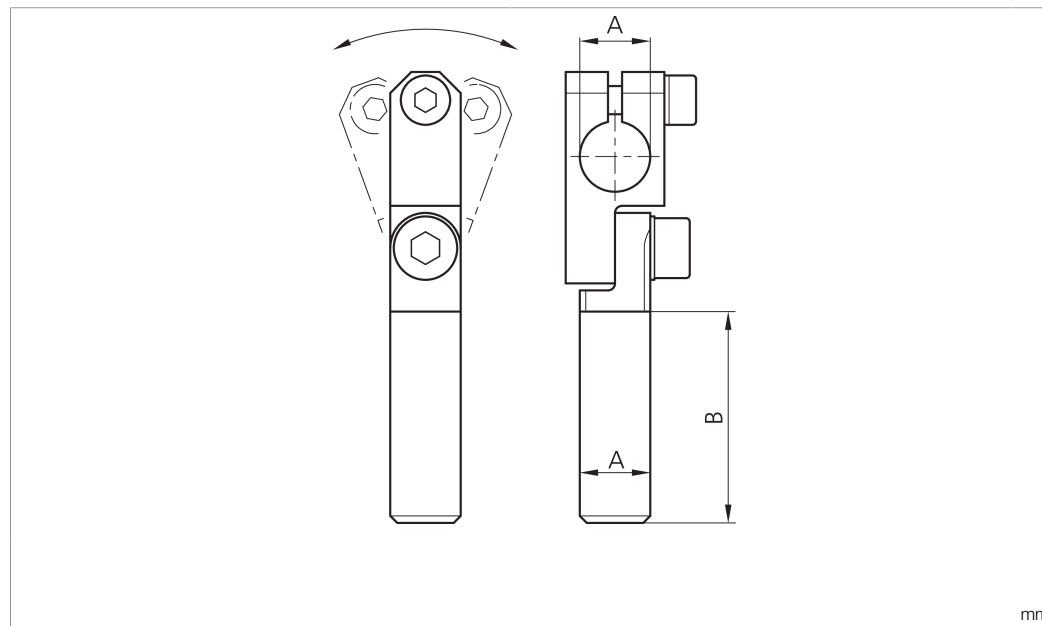

mm

Technische Daten	Technical data	Caractéristiques techniques	+20°C
Produktserie	Product series	Gamme de produits	Z-UBT-KL-MS Montagesystem / Z-UBT-KL-MS Assembly system / Système de montage Z-UBT-KL-MS
Geeignet für	To be used for	Convient pour	Klemmbolzen 10 mm / Clamping pin 10 mm / Boulon de serrage 10 mm
Durchmesser A	Diameter A	Diamètre A	10 mm
Maß B	Dimension B	Dimension B	90 mm
Besonderheiten	Characteristics	Particularités	Justierbar / Adjustable / Réglable
Material	Material	Matériau	Metall / Metal / Métal

Stand 03.11.23, Änderungen vorbehalten
As of 11/03/23, subject to change
État 03.11.23, sous réserve de modifications



SH-GLA-10-10-90

Articulated arm

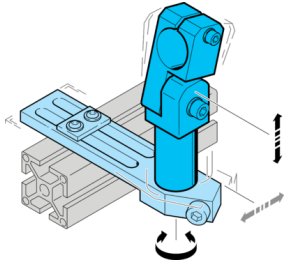

di-soric GmbH & Co. KG
 Steinbeisstraße 6
 DE-73660 Urbach
 Germany
 Tel: +49 (0) 7181/9879-0
 info@di-soric.com · www.di-soric.com

203903

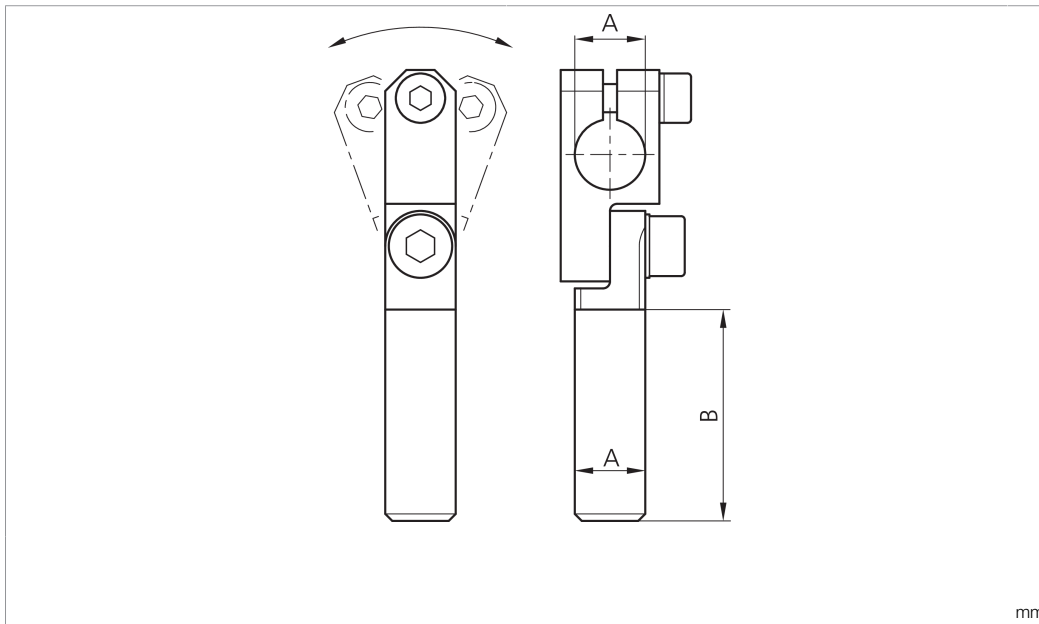

技术数据

产品系列

适合用于

直径 A

尺寸 B

特点

材料

+20°C

Z-UBT-KL-MS 安装系统

夹紧螺栓 10 mm

10 mm

90 mm

可校准

金属

版本 23.11.03, 保留变更权