

BW-BE 1-A

Befestigungswinkel
 Mounting bracket
 Équerre de fixation

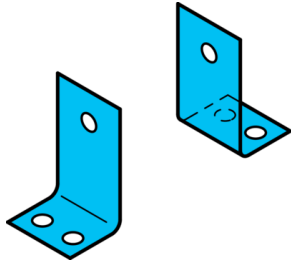

di-soric GmbH & Co. KG
 Steinbeisstraße 6
 DE-73660 Urbach
 Germany
 Tel: +49 (0) 7181/9879-0
 info@di-soric.com · www.di-soric.com

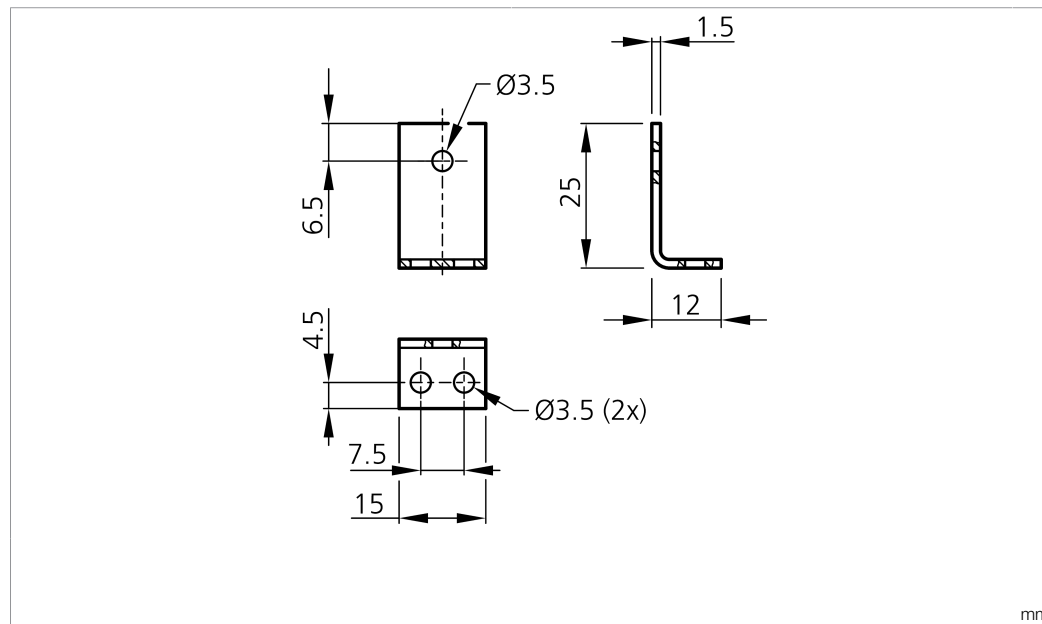

Technische Daten	Technical data	Caractéristiques techniques	
Geeignet für	To be used for	Convient pour	Balkenbeleuchtungen BE 1-A xxx/xxx / Joist lights BE 1-A xxx/xxx / Éclairages à barres BE 1-A xxx/xxx
Größe	Size	Dimensions	15 x 12 x 25 mm
Lieferumfang	Scope of delivery	Contenu de la livraison	Befestigungswinkel, Befestigungsmaterial / Mounting bracket, Fixing material / Équerre de fixation, Matériel de fixation

Stand 03.11.23, Änderungen vorbehalten
 As of 11/03/23, subject to change
 État 03.11.23, sous réserve de modifications



BW-BE 1-A

固定角铁

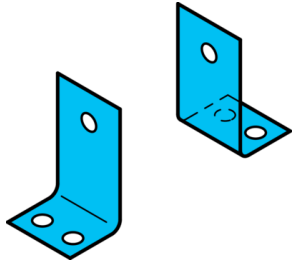

di-soric GmbH & Co. KG
 Steinbeisstraße 6
 DE-73660 Urbach
 Germany
 Tel: +49 (0) 7181/9879-0
 info@di-soric.com · www.di-soric.com

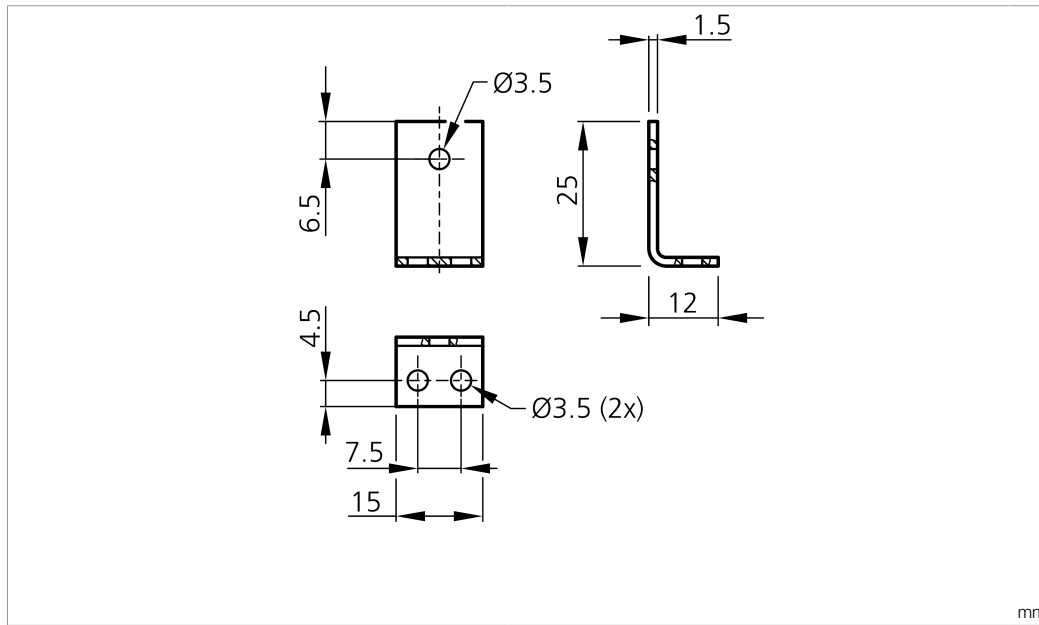

技术数据

适用于

条形光源 BE 1-A xxx/xxx

尺寸

15 x 12 x 25 mm

供货范围

固定角铁, 固定材料

版本 23.11.03, 保留变更权