

OR 31 K 1500 P3-3

Reflexionslichtschranke
Retroreflective sensor
Détecteur réflex

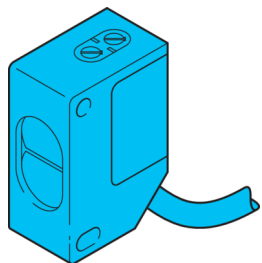

di-soric GmbH & Co. KG
Steinbeisstraße 6
DE-73660 Urbach
Germany
Tel: +49 (0) 7181/9879-0
info@di-soric.com · www.di-soric.com

209268



Stand 05.11.24, Änderungen vorbehalten
As of 11/05/24, subject to change
État 05.11.24, sous réserve de modifications

Funktion / Function / Fonction

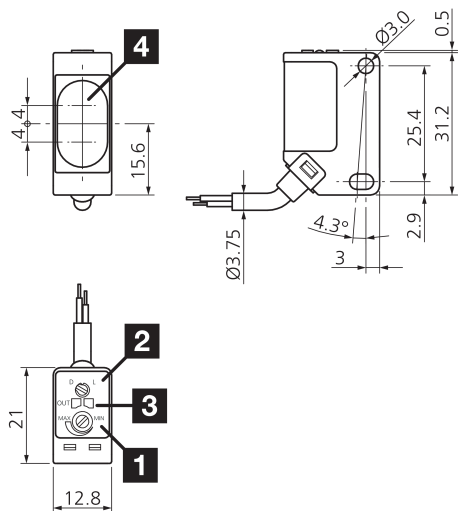

1) Empfindlichkeit / sensitivity / Sensibilité
2) NO/NC / NO/ NC / NO/NC

3) LED / LED / LED
4) Optische Achse / Optical axis / Axe optique mm

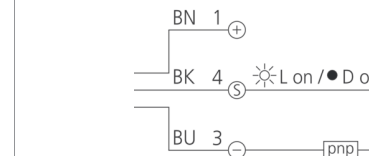

BK : schwarz / black / noir
BN : braun / brown / marron BU : blau / blue / bleu

Technische Daten	Technical data	Caractéristiques techniques	+20°C, 24 V DC
Lichtfarbe	Light color	Couleur de lumière	Rot / 630 nm / Red / 630 nm / Rouge / 630 nm
Reichweite	Range	Portée	50 ... 1500 mm
Bezugsreflektor	Referring reflector	Réflecteur de référence	Ø 84 mm, R 84
Betriebsspannung	Service voltage	Tension de service	10 ... 30 V DC
Leerlaufstrom (max.)	No-load current (max.)	Courant de marche à vide (max.)	30 mA
Schaltausgang	Switching output	Sortie de commutation	pnp, 100 mA, NO/NC
Umgebungstemperatur Betrieb	Ambient temperature during operation	Température ambiante de fonctionnement	-25 ... +70 °C
Schutzart	Protection type	Indice de protection	IP 67
Schutzklasse	Protection class	Classe de protection	III, Betrieb an Schutzkleinspannung / III, operation on protective low voltage / III, utilisation en très basse tension de sécurité

Sicherheitshinweise



Allgemeiner Sicherheitshinweis

WARNUNG! Kein Sicherheitsbauteil gemäß 2006/42/EG und EN 61496-1 /-2! Darf nicht zum Personenschutz eingesetzt werden! Nichtbeachtung kann zu Tod oder schwersten Verletzungen führen! Nur bestimmungsgemäß verwenden!

Safety instructions



General safety notice

WARNING! Not a safety component pursuant to 2006/42/EG and EN 61496-1/-2! May not be used for personal protection! Non-compliance can lead to death or serious injuries! Only use as directed!

Consignes de sécurité



Consigne de sécurité générale

AVERTISSEMENT ! Ce produit n'est pas un composant de sécurité au sens des réglementations 2006/42/CE et NF EN 61496-1/-2 ! Ne pas l'utiliser pour la protection des personnes ! Le non-respect de cette consigne peut entraîner la mort ou des blessures graves ! N'utiliser le produit que selon son utilisation conforme !

OR 31 K 1500 P3-3

镜反射光电开关

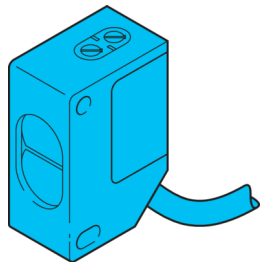

di-soric GmbH & Co. KG
Steinbeisstraße 6
DE-73660 Urbach
Germany
Tel: +49 (0) 7181/9879-0
info@di-soric.com · www.di-soric.com

209268



版本 24.11.05, 保留变更权

功能

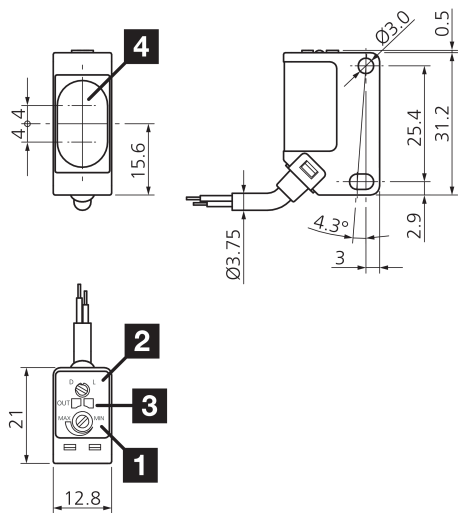

1) 灵敏度
2) NO/NC

3) LED
4) 光轴

mm

BK : 黑色
BN : 棕色

BU : 蓝色

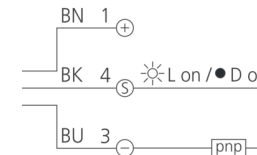

技术数据

光色	+20°C, 24 V DC
作用距离	红色 / 630 nm
基准反射镜	50 ... 1500 mm
工作电压	Ø 84 mm, R 84
空载电流 (最大)	10 ... 30 V DC
开关输出端	30 mA
工作环境温度	pnp, 100 mA, NO/NC
防护等级	-25 ... +70 °C
防护等级	IP 67
防护等级	III, 在安全特低电压下工作

安全提示



一般安全提示

警告！没有符合 2006/42/EU 和 EN 61496-1 /-2 标准的安全结构件！不得用于人身安全保护！不遵守规定会导致死亡或重伤危险！仅按规定使用！