

HS-S-15-200-V

Montagestange
 Mounting rod
 Tige de montage



di-soric GmbH & Co. KG
 Steinbeisstraße 6
 DE-73660 Urbach
 Germany
 Tel: +49 (0) 7181/9879-0
 info@di-soric.com · www.di-soric.com

209459

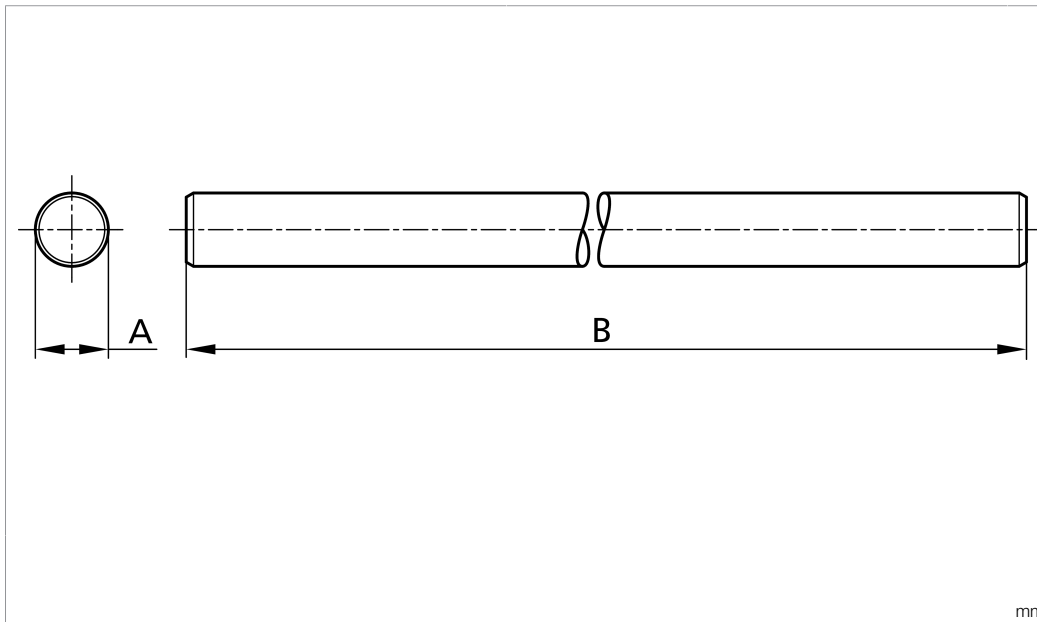

Technische Daten	Technical data	Caractéristiques techniques	+20°C
Produktserie	Product series	Gamme de produits	Z-UBT-KL-MS Montagesystem / Z-UBT-KL-MS Assembly system / Système de montage Z-UBT-KL-MS
Durchm. Montagezapfen/Bohrung	Diameter Mounting pin / boring	Diam. tourillon de montage/alésage	Ø 15 mm
Maß B	Dimension B	Dimension B	200 mm
Material	Material	Matériau	Edelstahl / Stainless steel / Acier inoxydable

Stand 03.11.23, Änderungen vorbehalten
 As of 11/03/23, subject to change
 État 03.11.23, sous réserve de modifications



HS-S-15-200-V

装配杆



di-soric GmbH & Co. KG
Steinbeisstraße 6
DE-73660 Urbach
Germany
Tel: +49 (0) 7181/9879-0
info@di-soric.com · www.di-soric.com

209459

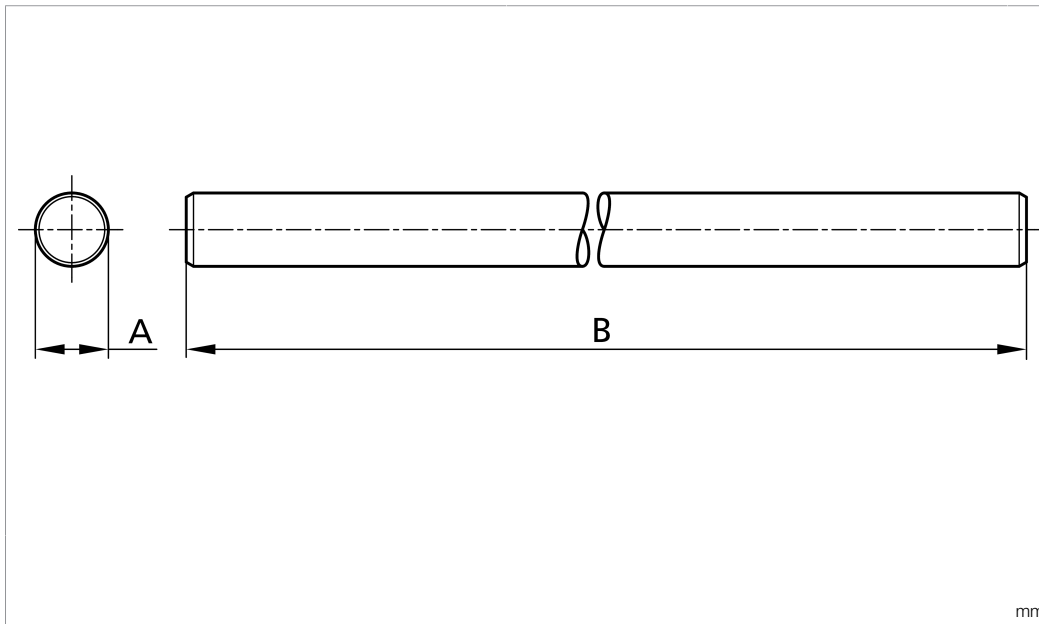

技术数据

产品系列

直径装配栓/钻孔

尺寸 B

材料

+20°C

Z-UBT-KL-MS 安装系统

Ø 15 mm

200 mm

不锈钢

版本 23.11.03, 保留变更权

Systemhalter Serie HS

Grundhalter Ø 12 mm

System holder series HS

Basic system holder Ø 12 mm

Systèmes de fixation Série HS

12 mm du support Ø de système de base

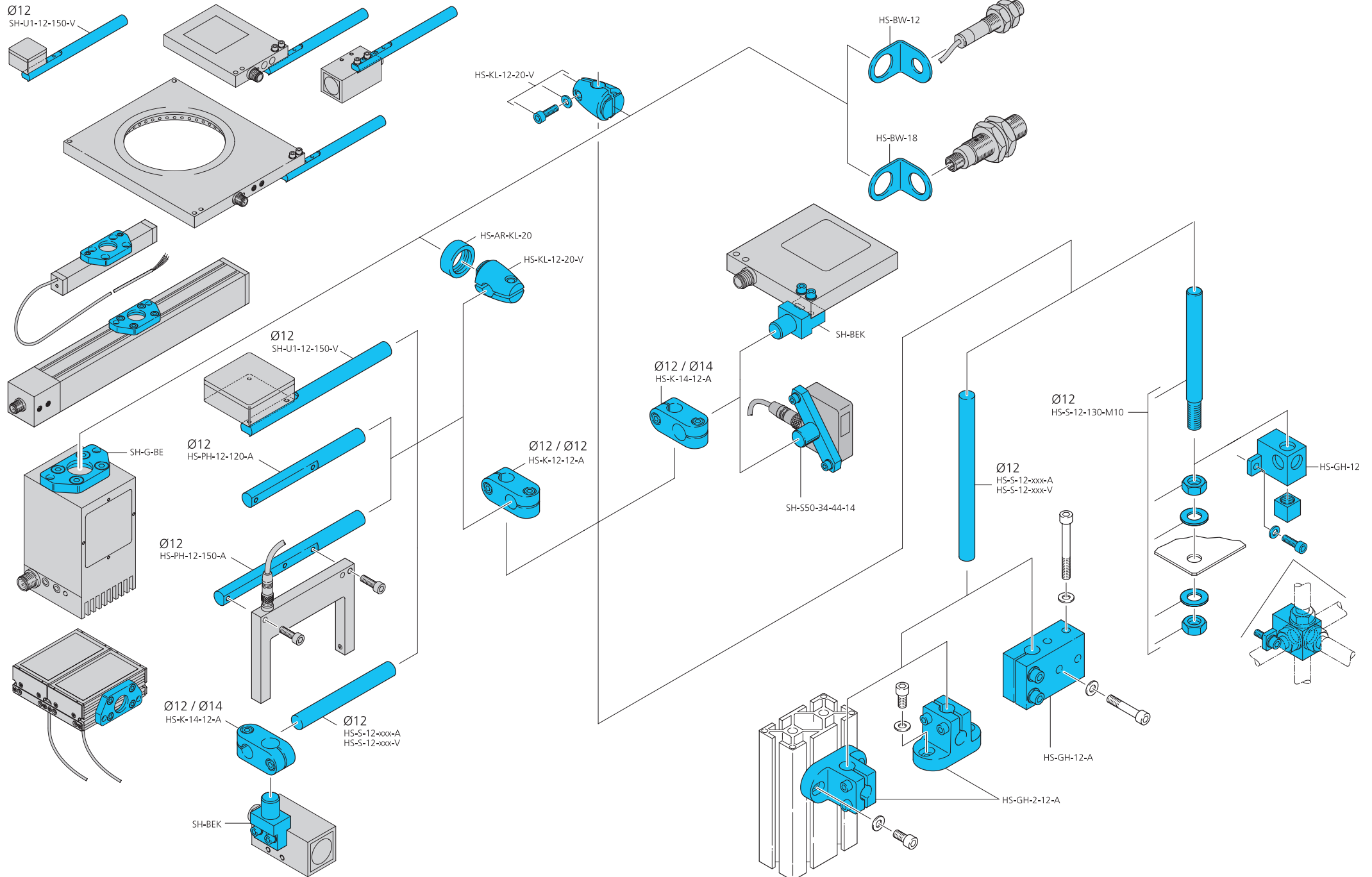

Systemhalter Serie HS

Grundhalter Ø 15 mm

System holder series HS

Basic system holder Ø 15 mm

Systèmes de fixation Série HS

15 mm du support Ø de système de base

