

IRB 20 NS-B3

Induktiver Ringsensor
Inductive ring sensor
Capteur annulaire inductif

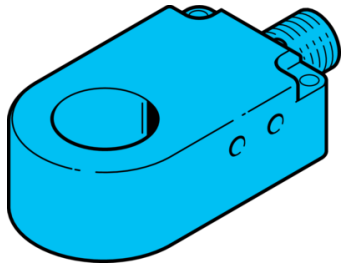

di-soric GmbH & Co. KG
Steinbeisstraße 6
DE-73660 Urbach
Germany
Tel: +49 (0) 7181/9879-0
info@di-soric.com · www.di-soric.com

209917



Stand 17.05.24, Änderungen vorbehalten

As of 05/17/24, subject to change

État 17.05.24, sous réserve de modifications



Enclosure Type 4X (indoor use only), 12, 13 Supply Class 2 NFPA 79 Applications only. For adapters providing field wiring means refer to product information or customer support.

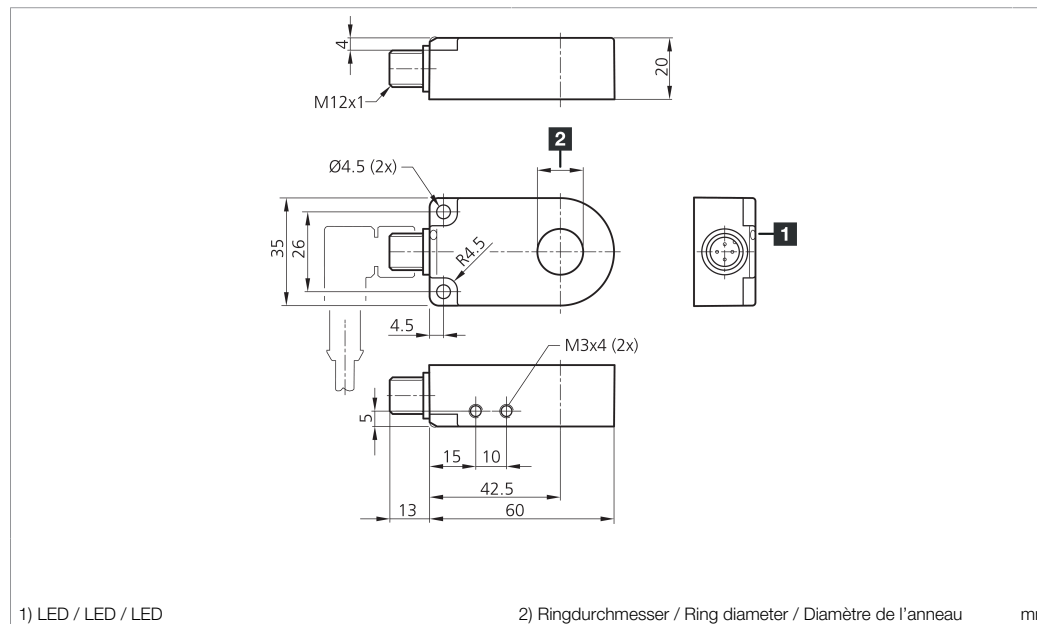

1) LED / LED / LED

2) Ringdurchmesser / Ring diameter / Diamètre de l'anneau mm

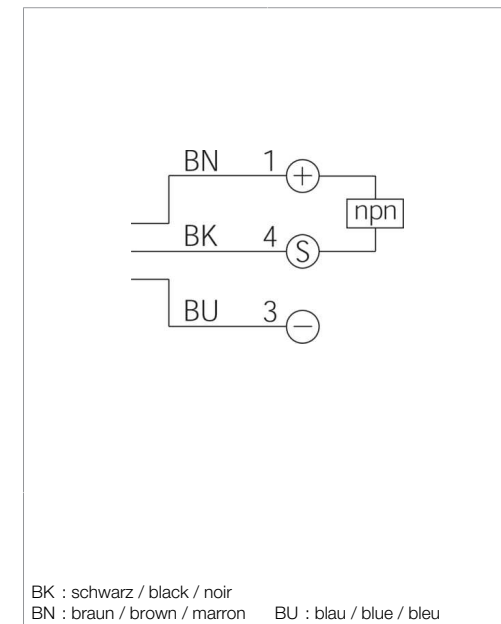

BK : schwarz / black / noir

BN : braun / brown / marron

BU : blau / blue / bleu

Technische Daten	Technical data	Caractéristiques techniques	+20°C, 24 V DC
Innendurchmesser	Internal diameter	Diamètre intérieur	20,1 mm / 20.1 mm / 20,1 mm
Betriebsspannung	Service voltage	Tension de service	10 ... 35 V DC (Supply Class 2)
Schaltausgang	Switching output	Sortie de commutation	npn, 200 mA, NO
Leerlaufstrom (max.)	No-load current (max.)	Courant de marche à vide (max.)	11 mA
Teilegeschwindigkeit (max.)	Speed of parts (max.)	Vitesse de passage des pièces (max.)	35 m/s
Impulsverlängerung	Pulse stretching	Prolongation de l'impulsion	150 ms
Schutzart	Protection type	Indice de protection	IP 67
Umgebungstemperatur Betrieb	Ambient temperature during operation	Température ambiante de fonctionnement	-25 ... +70 °C

Sicherheitshinweise



Allgemeiner Sicherheitshinweis

WARNUNG! Kein Sicherheitsbauteil gemäß 2006/42/EG und EN 61496-1/-2! Darf nicht zum Personenschutz eingesetzt werden! Nichtbeachtung kann zu Tod oder schwersten Verletzungen führen! Nur bestimmungsgemäß verwenden!

Safety instructions



General safety notice

WARNING! Not a safety component pursuant to 2006/42/EG and EN 61496-1/-2! May not be used for personal protection! Non-compliance can lead to death or serious injuries! Only use as directed!

Consignes de sécurité



Consigne de sécurité générale

AVERTISSEMENT ! Ce produit n'est pas un composant de sécurité au sens des réglementations 2006/42/CE et NF EN 61496-1/-2 ! Ne pas l'utiliser pour la protection des personnes ! Le non-respect de cette consigne peut entraîner la mort ou des blessures graves ! N'utiliser le produit que selon son utilisation conforme !

IRB 20 NS-B3

电感式环形传感器

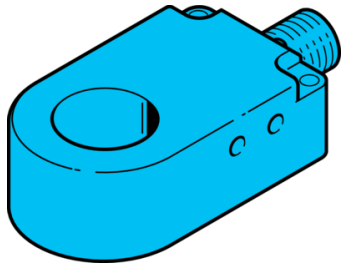

di-soric GmbH & Co. KG
Steinbeisstraße 6
DE-73660 Urbach
Germany
Tel: +49 (0) 7181/9879-0
info@di-soric.com · www.di-soric.com

209917



版本 24.05.17, 保留变更权

UL LISTED
IND. CONT. EQ.
29W7

Enclosure Type 4X (indoor use only), 12, 13 Supply Class 2 NFPA 79 Applications only. For adapters providing field wiring means refer to product information or customer support.

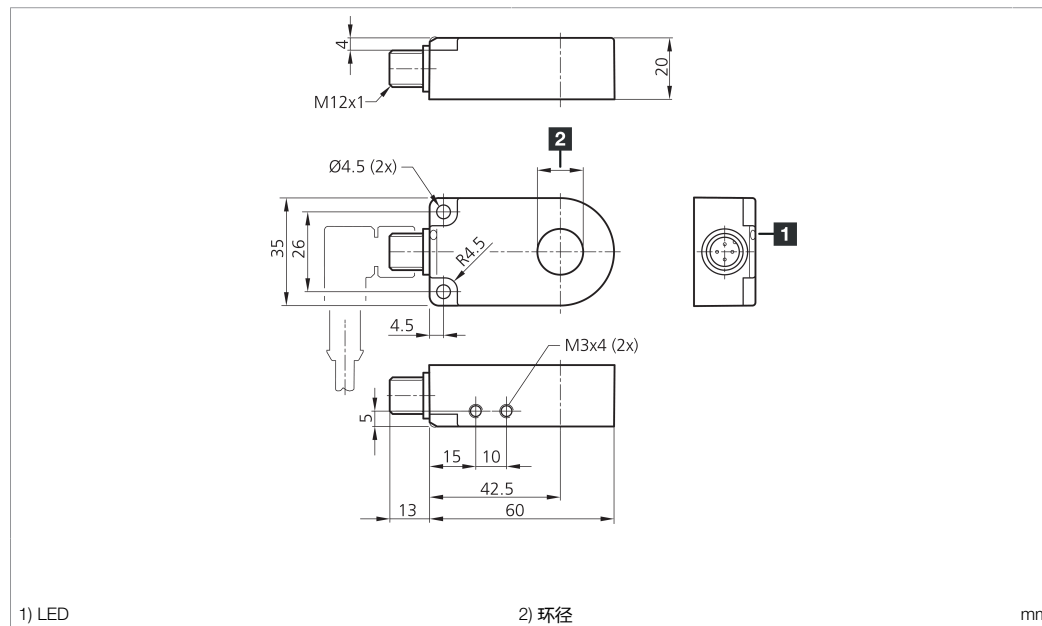

1) LED

2) 环径

mm

BK : 黑色
BN : 棕色
BU : 蓝色

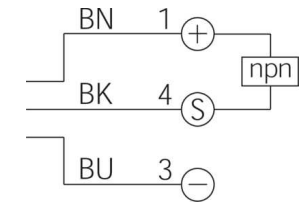

技术数据

内径	20.1 mm
工作电压	10 ... 35 V DC (Supply Class 2)
开关输出端	npn, 200 mA, NO
空载电流 (最大)	11 mA
零件速度 (最大)	35 m/s
脉冲延展	150 ms
防护等级	IP 67
工作环境温度	-25 ... +70 °C

安全提示



一般安全提示

警告！没有符合 2006/42/EU 和 EN 61496-1 /-2 标准的安全结构件！不得用于人身安全保护！不遵守规定会导致死亡或重伤危险！仅按规定使用！

Induktiver Ringsensor

Inductive ring sensors

Détecteurs inductifs annulaires

Minimale Montageabstände bei Betrieb mehrerer Ringsensoren

Min. mounting distances when operating several ring sensors

Distance de montage min. en cas de montage d'anneaux de détection rapprochés



Metallische Abschirmbleche, die zwischen den Ringsensoren positioniert werden, können die Mindestmontageabstände erheblich reduzieren. Besonders gut eignet sich Aluminiumblech. Die Abschirmwirkung steigt mit der Größe und Stärke des Abschirmblechs. Eine unempfindlichere Einstellung wirkt sich ebenfalls positiv auf den Mindestmontageabstand aus.

Metal protection shields, positioned between ring sensors reduce the min. mounting distance significantly. Aluminum is particularly suited. The protection impact increases with size and thickness of the shield. Choosing the less sensitive alignment is another positive factor for the min. mounting distance.

Des plaques de protection métalliques installées entre les anneaux de détection réduisent considérablement la distance mini. de montage. L'aluminium est particulièrement approprié. La protection aux chocs augmente selon la taille et l'épaisseur de la plaque. Choisir l'alignement le moins sensible est un autre facteur positif pour réduire la distance de montage.

Montageart A:

Mounting method A:

Méthode de montage A:



Montageart B:

Mounting method B:

Méthode de montage B:



Typ / Model / Modèle	X (mm)	Y (mm)	Min. Montageabstand zu Metall Z in mm (bei D2=D)		Min. Bohrungsdurchmesser D1 in mm (bei Z=0mm)	
			Min. mounting distance to metal Z mm (at D2=D)	Distance de montage min. du métal Z (mm) (avec D2 = D)	Min. hole diameter D1 mm (at Z=0 mm)	Diamètre mini. De l'orifice D1 (mm) (avec Z = 0 mm)
IR 6 ...	0	0	0	0	11,0	11,0
IRD 6 ...	5	20	0	0	11,0	11,0
IR 10 ...	0	0	0	0	15,0	15,0
IRB 10 ...	5	30	5	5	-	-
IRD 10 ...	20	60	0	0	15,0	15,0
IR 15 ...	5	5	0	0	20,0	20,0
IRB 15 ...	20	50	15	15	-	-
IRD 15 ...	60	120	2	2	20,0	20,0
IR 20 ...	10	50	2	2	25,0	25,0
IRB 20 ...	50	80	20	20	-	-
IRD 20 ...	70	130	4	4	25,0	25,0
IR 25 ...	10	50	2	2	32,0	32,0
IRD 25 ...	150	200	8	8	32,0	32,0
IRB 27 ...	60	100	25	25	-	-

Zubehör/Accessories/Accessoires

Befestigungswinkel

Mounting bracket

Équerre de fixation



BWS-IR01

BWS-IR01

BWS-IR01