

IRSD-10-G3-B4

Induktiver Ringsensor
Inductive ring sensor
Capteur annulaire inductif

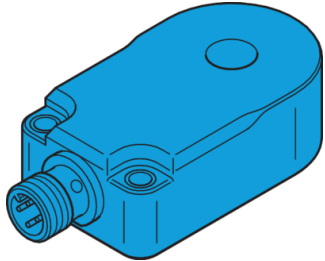

di-soric GmbH & Co. KG
Steinbeisstraße 6
DE-73660 Urbach
Germany
Tel: +49 (0) 7181/9879-0
info@di-soric.com · www.di-soric.com

213667

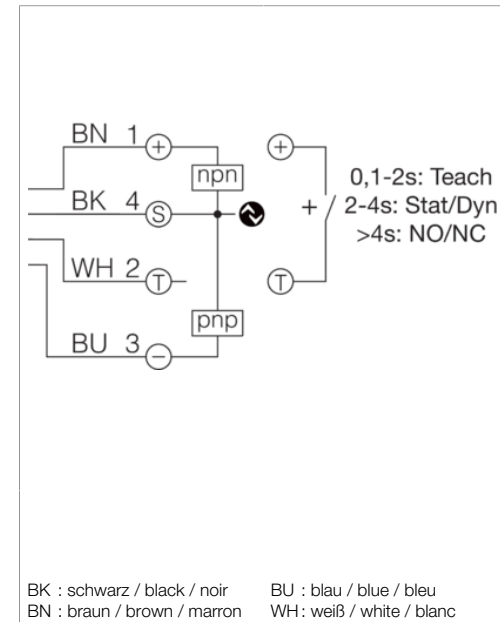
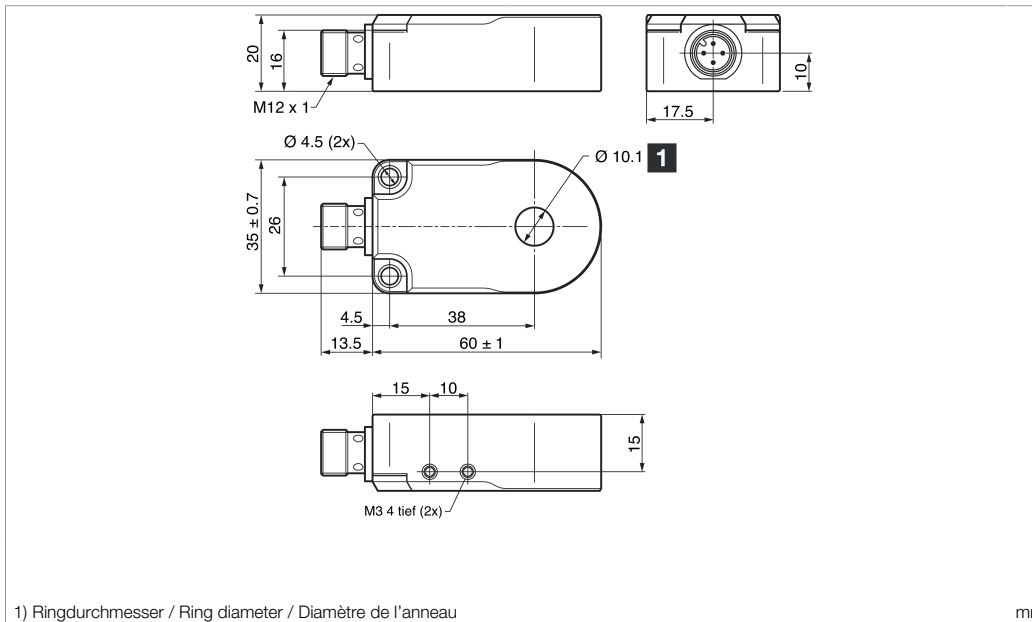

Technische Daten	Technical data	Caractéristiques techniques	+20°C, 24 V DC
Innendurchmesser	Internal diameter	Diamètre intérieur	10,1 mm / 10.1 mm / 10,1 mm
Betriebsspannung	Service voltage	Tension de service	10 ... 30 V DC
Schaltausgang	Switching output	Sortie de commutation	Gegentakt/PNP/NPN, 100 mA, NO/NC / Push-pull/PNP/NPN, 100 mA, NO/NC / Push-pull/PNP/NPN, 100 mA, NO/NC
Leerlaufstrom (max.)	No-load current (max.)	Courant de marche à vide (max.)	30 mA
Teilgeschwindigkeit (min.)	Speed of parts (min.)	Vitesse de passage des pièces (min.)	0,1 m/s / 0.1 m/s / 0,1 m/s
Teilgeschwindigkeit (max.)	Speed of parts (max.)	Vitesse de passage des pièces (max.)	35 m/s
Schutzart	Protection type	Indice de protection	IP 67
Umgebungstemperatur Betrieb	Ambient temperature during operation	Température ambiante de fonctionnement	-25 ... +70 °C

Stand 16.07.24, Änderungen vorbehalten
As of 07/16/24, subject to change
État 16.07.24, sous réserve de modifications

Enclosure Type 4X (indoor use only), 12, 13 Supply Class 2 NFPA 79 Applications only. For adapters providing field wiring means refer to product information or customer support.

Sicherheitshinweise

Allgemeiner Sicherheitshinweis
WARNUNG! Kein Sicherheitsbauteil gemäß 2006/42/EG und EN 61496-1/-2! Darf nicht zum Personenschutz eingesetzt werden! Nichtbeachtung kann zu Tod oder schwersten Verletzungen führen! Nur bestimmungsgemäß verwenden!

Safety instructions

General safety notice
WARNING! Not a safety component pursuant to 2006/42/EG and EN 61496-1/-2! May not be used for personal protection! Non-compliance can lead to death or serious injuries! Only use as directed!

Consignes de sécurité

Consigne de sécurité générale
AVERTISSEMENT ! Ce produit n'est pas un composant de sécurité au sens des réglementations 2006/42/CE et NF EN 61496-1/-2 ! Ne pas l'utiliser pour la protection des personnes ! Le non-respect de cette consigne peut entraîner la mort ou des blessures graves ! N'utiliser le produit que selon son utilisation conforme !

IRSD-10-G3-B4

电感式环形传感器

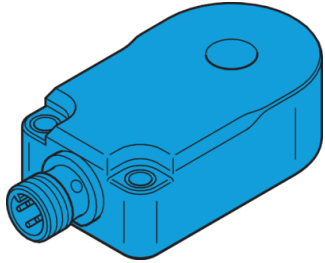

di-soric GmbH & Co. KG
Steinbeisstraße 6
DE-73660 Urbach
Germany
Tel: +49 (0) 7181/9879-0
info@di-soric.com · www.di-soric.com

213667



版本 24.07.16, 保留变更权



Enclosure Type 4X (indoor use only), 12, 13 Supply Class 2 NFPA 79 Applications only. For adapters providing field wiring means refer to product information or customer support.

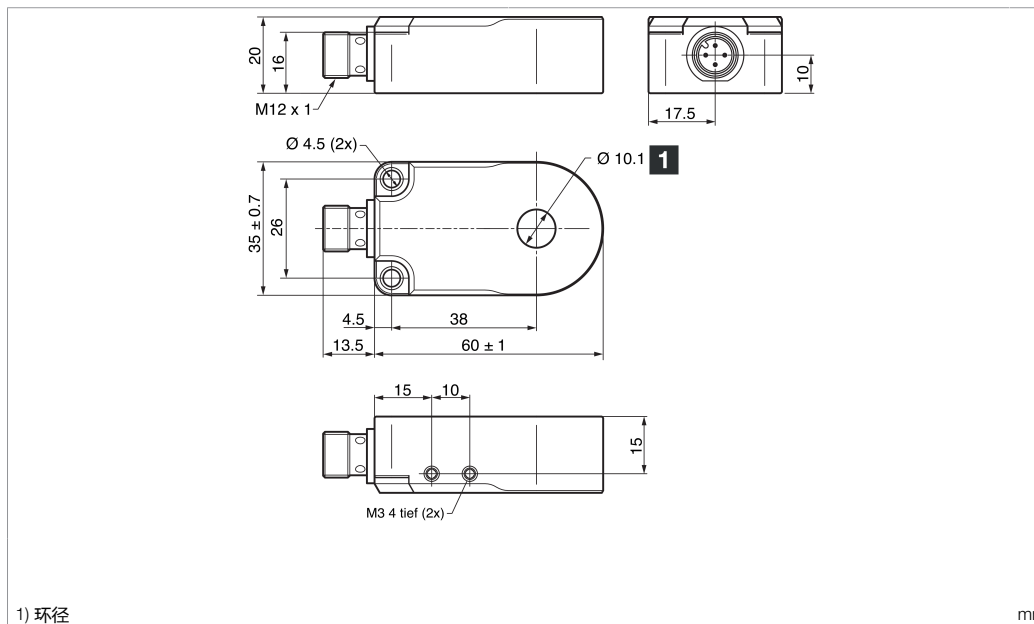

1) 环径

mm

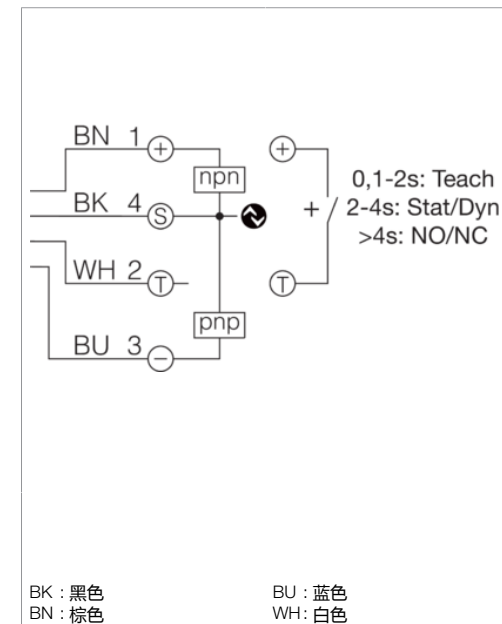

BK : 黑色
BN : 棕色

BU : 蓝色
WH : 白色

技术数据

内径	10.1 mm
工作电压	10 ... 30 V DC
开关输出端	推挽式/PNP/NPN, 100 mA, NO/NC
空载电流 (最大)	30 mA
零件速度 (最小)	0.1 m/s
零件速度 (最大)	35 m/s
防护等级	IP 67
工作环境温度	-25 ... +70 °C

安全提示



一般安全提示

警告！没有符合 2006/42/EU 和 EN 61496-1 /-2 标准的安全结构件！不得用于人身安全保护！不遵守规定会导致死亡或重伤危险！仅按规定使用！