

# SH-GLA-20-20-50

Gelenkarm  
Articulated arm  
Bras articulé

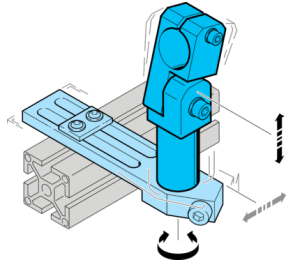

di-soric GmbH & Co. KG  
Steinbeisstraße 6  
DE-73660 Urbach  
Germany  
Tel: +49 (0) 7181/9879-0  
info@di-soric.com · www.di-soric.com

203907

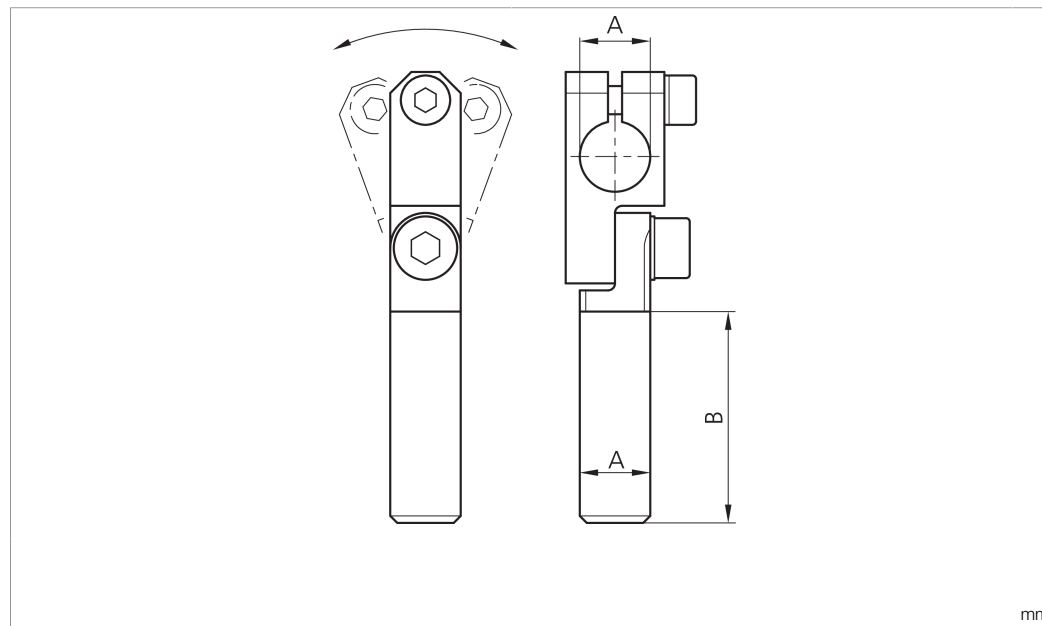

Technische Daten	Technical data	Caractéristiques techniques	+20°C
Produktserie	Product series	Gamme de produits	Z-UBT-KL-MS Montagesystem / Z-UBT-KL-MS Assembly system / Système de montage Z-UBT-KL-MS
Geeignet für	To be used for	Convient pour	Klemmbolzen 20 mm / Clamping pin 20 mm / Boulon de serrage 20 mm
Durchmesser A	Diameter A	Diamètre A	20 mm
Maß B	Dimension B	Dimension B	50 mm
Besonderheiten	Characteristics	Particularités	Justierbar / Adjustable / Réglable
Material	Material	Matériau	Metall / Metal / Métal

Stand 03.11.23, Änderungen vorbehalten  
As of 11/03/23, subject to change  
État 03.11.23, sous réserve de modifications



**SH-GLA-20-20-50**

Articulated arm

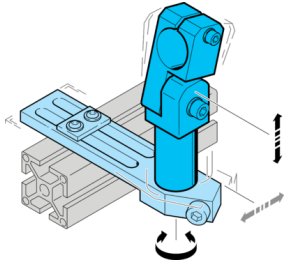

di-soric GmbH & Co. KG  
 Steinbeisstraße 6  
 DE-73660 Urbach  
 Germany  
 Tel: +49 (0) 7181/9879-0  
 info@di-soric.com · www.di-soric.com

203907

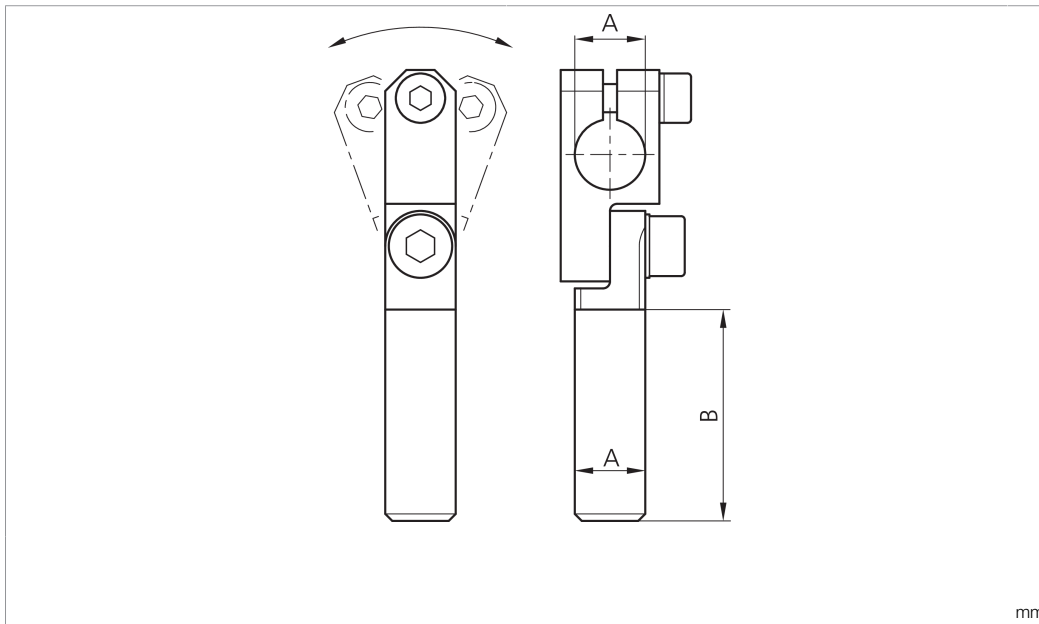

**技术数据**

产品系列

适合用于

直径 A

尺寸 B

特点

材料

**+20°C**

Z-UBT-KL-MS 安装系统

夹紧螺栓 20 mm

20 mm

50 mm

可校准

金属

版本 23.11.03, 保留变更权