

D7B 18 VB 05 NS-B3

Induktiver Näherungssensor
Inductive proximity sensor
Détecteur de proximité inductif

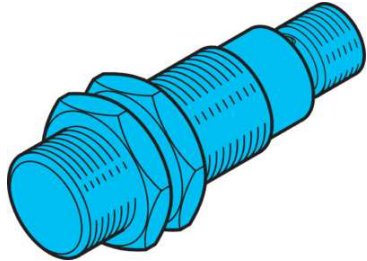

di-soric GmbH & Co. KG
Steinbeisstraße 6
DE-73660 Urbach
Germany
Tel: +49 (0) 7181/9879-0
info@di-soric.com · www.di-soric.com

209422



Stand 17.05.24, Änderungen vorbehalten
As of 05/17/24, subject to change
État 17.05.24, sous réserve de modifications

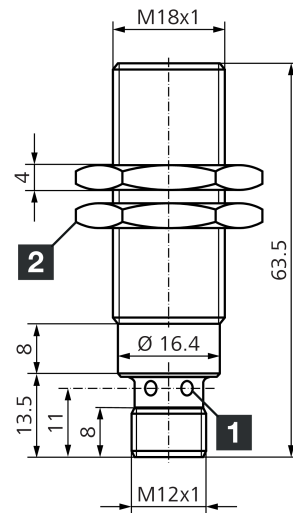

1) LED 4 x 90° (gelb) / LED 4 x 90° (yellow) / LED 4 x 90° (jaune) mm
2) Schlüsselweite 24 mm / Width over flats 24 mm / Ouverture de clé 24 mm

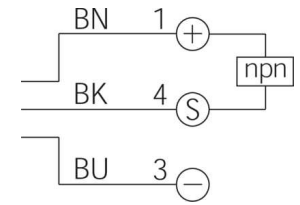

BK : schwarz / black / noir
BN : braun / brown / marron BU : blau / blue / bleu

Technische Daten	Technical data	Caractéristiques techniques	+20°C, 24 V DC
Einbauart	Installation type	Type de montage	bündig / Flush / Affleurant
Schaltabstand	Switching distance	Distance de commutation	5 mm
Betriebsspannung	Service voltage	Tension de service	10 ... 30 V DC
Schaltausgang	Switching output	Sortie de commutation	npn, 200 mA, NO
Auswertung	Evaluation	Évaluation	digital / digital / Numérique
Umgebungstemperatur Betrieb	Ambient temperature during operation	Température ambiante de fonctionnement	-25 ... +70 °C
Schutzart	Protection type	Indice de protection	IP 68, IP 69K
Anschluss	Connection	Raccordement	Stecker, M12, 4-polig, A-kodiert / Connector, M12, 4-pin, A-coded / Connecteur, M12, 4 pôles, Codage A

Sicherheitshinweise	Safety instructions	Consignes de sécurité
Allgemeiner Sicherheitshinweis WARNUNG! Kein Sicherheitsbauteil gemäß 2006/42/EG und EN 61496-1/-2! Darf nicht zum Personenschutz eingesetzt werden! Nichtbeachtung kann zu Tod oder schwersten Verletzungen führen! Nur bestimmungsgemäß verwenden!	General safety notice WARNING! Not a safety component pursuant to 2006/42/EG and EN 61496-1/-2! May not be used for personal protection! Non-compliance can lead to death or serious injuries! Only use as directed!	Consigne de sécurité générale AVERTISSEMENT ! Ce produit n'est pas un composant de sécurité au sens des réglementations 2006/42/CE et NF EN 61496-1/-2 ! Ne pas l'utiliser pour la protection des personnes ! Le non-respect de cette consigne peut entraîner la mort ou des blessures graves ! N'utiliser le produit que selon son utilisation conforme !

D7B 18 VB 05 NS-B3

电感式接近传感器

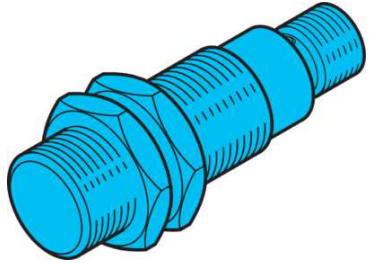

di-soric GmbH & Co. KG
Steinbeisstraße 6
DE-73660 Urbach
Germany
Tel: +49 (0) 7181/9879-0
info@di-soric.com · www.di-soric.com

209422



版本 24.05.17, 保留变更权

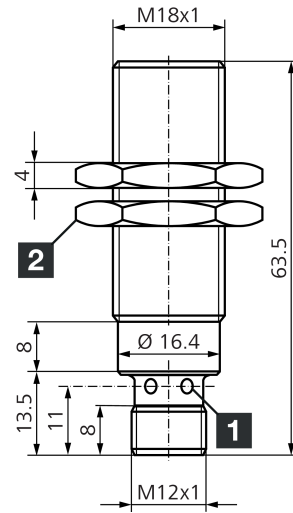

1) LED 4 x 90° (黄色)

2) 开口度 24 mm

mm

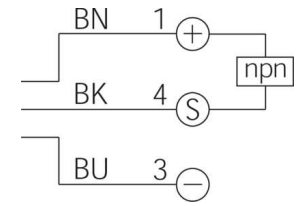

BK : 黑色
BN : 棕色

BU : 蓝色

技术数据

内装方式

感应距离

工作电压

开关输出端

评估

工作环境温度

防护等级

连接

+20°C, 24 V DC

齐平

5 mm

10 ... 30 V DC

npn, 200 mA, NO

数字量

-25 ... +70 °C

IP 68, IP 69K

插头, M12, 4 针, A 编码

安全提示



一般安全提示

警告！没有符合 2006/42/EU 和 EN 61496-1/-2 标准的安全结构件！不得用于人身安全保护！不遵守规定会导致死亡或重伤危险！仅按规定使用！

Induktiver Näherungsschalter

Inductive Proximity Switch

Détecteur inductif de proximité

Ansprechkurve

Response diagram

Courbe de réponse

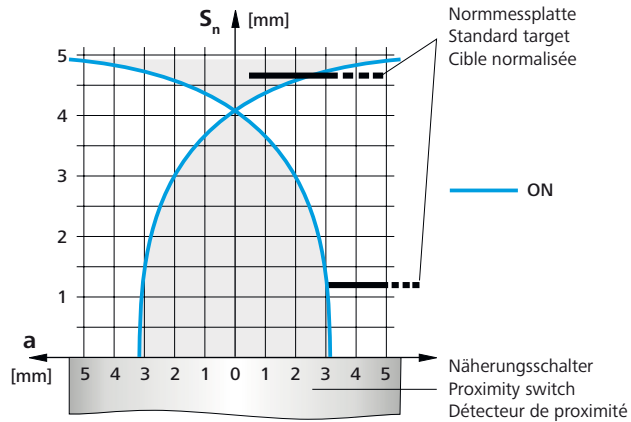

Reduktionsfaktoren für Messplatte aus / Correction factors for target of / Coefficients de réduction pour cible en:

Stahl FE 360		Kupfer		Aluminium		Messing		Edelstahl 1mm / 2mm dick	
Steel FE 360	1,0	copper	0,8	aluminium	1,0	brass	1,3	stainless steel 1mm / 2mm thick	0,3 / 0,7
Acier FE 360		civre		aluminium		laiton		acier INOX épaisseur 1mm / 2mm	

Reduktionsfaktoren für bündigen Einbau in Träger aus / Correction factors for embeddable mounting in support of / Coefficients de réduction pour montage noyé dans support en:

Stahl FE 360		Aluminium		Messing		Edelstahl	
Steel FE 360	0,9	aluminium	0,9	brass	0,9	stainless steel	0,9
Acier FE 360		aluminium		laiton		acier INOX	

Einbau

Mounting

Montage

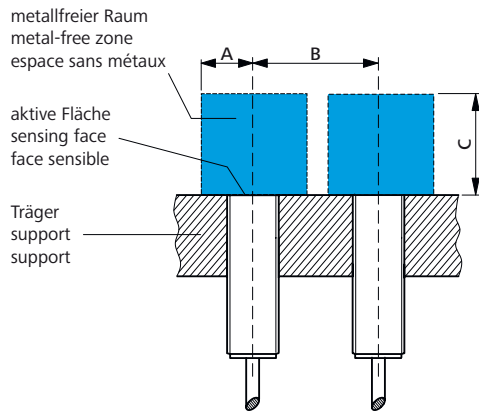

Freizone

Für sicheres Arbeiten des Gerätes ist die Einhaltung folgender Freizonen unerlässlich:

Free zone

Providing the following free zones is mandatory for reliable operation:

Zone libre

Pour un fonctionnement sûr, le respect de zones libres est indispensable.

Abstand (mm)

Dimension (mm)

Distance (mm)

A	15	15	15
B	30	30	30
C	15	15	15