

# HS-AR-KL-20

Adapterring  
 Adapter ring  
 Bague d'adaptation

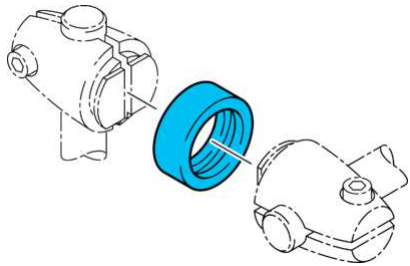

di-soric GmbH & Co. KG  
 Steinbeisstraße 6  
 DE-73660 Urbach  
 Germany  
 Tel: +49 (0) 7181/9879-0  
 info@di-soric.com · www.di-soric.com

209483

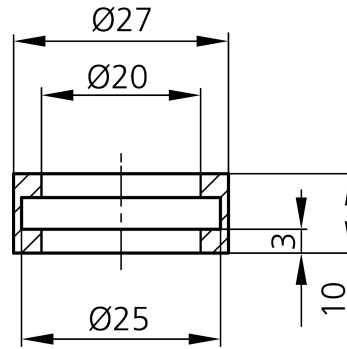

mm

Technische Daten	Technical data	Caractéristiques techniques	+20°C
Produktserie	Product series	Gamme de produits	Z-UBT-KL-MS Montagesystem / Z-UBT-KL-MS Assembly system / Système de montage Z-UBT-KL-MS
Durchm. Montagezapfen/Bohrung	Diameter Mounting pin / boring	Diam. tourillon de montage/alésage	Ø 20 / Ø 20 mm
Material	Material	Matériau	Edelstahl, V4A, 1.4404 / AISI 316L - 1.4571 / AISI 316Ti / Stainless steel, V4A, 1.4404 / AISI 316L - 1.4571 / AISI 316Ti / Acier inoxydable, V4A, 1.4404 / AISI 316L - 1.4571 / AISI 316Ti

Stand 03.11.23, Änderungen vorbehalten  
 As of 11/03/23, subject to change  
 État 03.11.23, sous réserve de modifications



**HS-AR-KL-20**

转接环

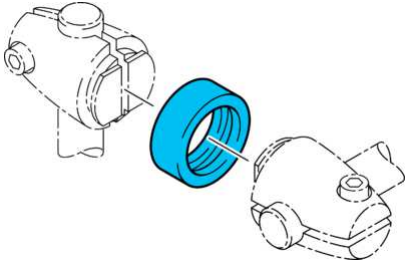

di-soric GmbH & Co. KG  
Steinbeisstraße 6  
DE-73660 Urbach  
Germany  
Tel: +49 (0) 7181/9879-0  
info@di-soric.com · www.di-soric.com

209483

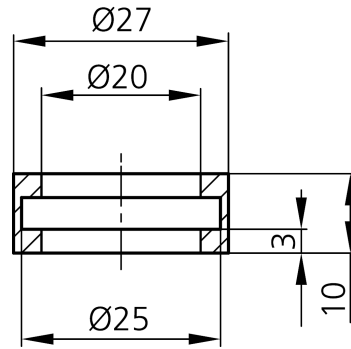

mm

**技术数据**

产品系列

直径装配栓/钻孔

材料

**+20°C**

Z-UBT-KL-MS 安装系统

Ø 20 / Ø 20 mm

不锈钢, V4A, 1.4404 / AISI 316L - 1.4571 / AISI 316Ti

版本 23.11.03, 保留变更权

# Systemhalter Serie HS

Grundhalter Ø 12 mm

# System holder series HS

Basic system holder Ø 12 mm

# Systèmes de fixation Série HS

12 mm du support Ø de système de base

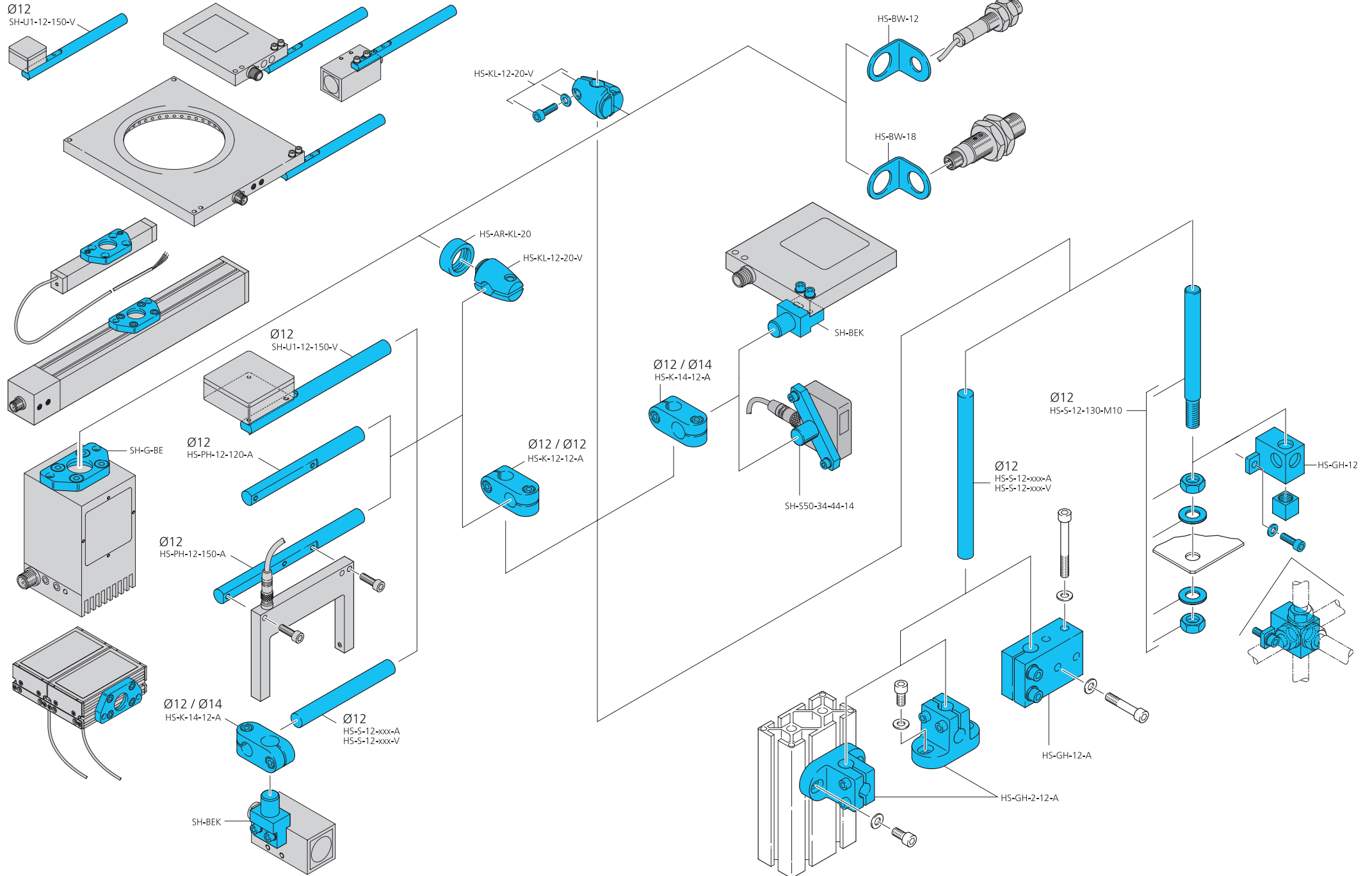

# Systemhalter Serie HS

Grundhalter Ø15 mm

# System holder series HS

Basic system holder Ø15 mm

# Systèmes de fixation Série HS

15 mm du support Ø de système de base

