

BE-R30-G5-K-BS-CLR

Ringbeleuchtung
Ringlight
Anneau lumineux

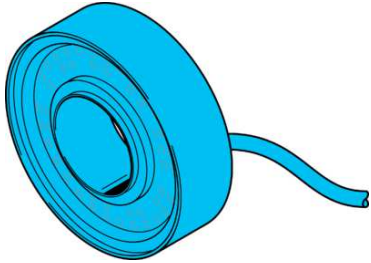

di-soric GmbH & Co. KG
Steinbeisstraße 6
DE-73660 Urbach
Germany
Tel: +49 (0) 7181/9879-0
info@di-soric.com · www.di-soric.com

209554



Stand 16.07.24, Änderungen vorbehalten
As of 07/16/24, subject to change
État 16.07.24, sous réserve de modifications

Enclosure Type 1 Supply Class 2
NFPA 79 Applications only. For adapters providing field wiring means refer to product information or customer support.

IND. CONT. EQ. 29W7

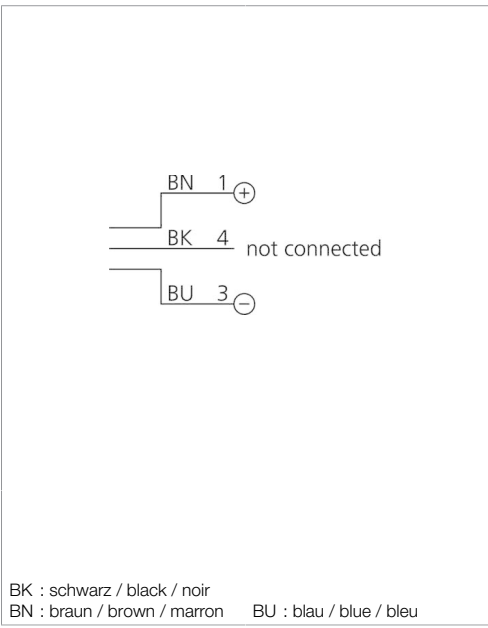
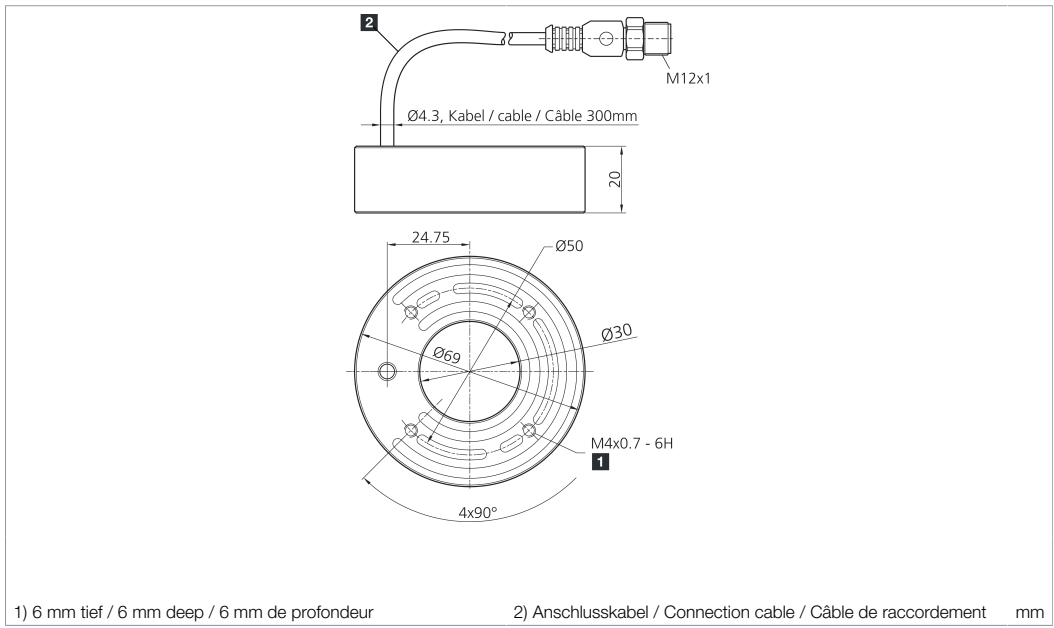

Technische Daten	Technical data	Caractéristiques techniques	+20°C, 24 V DC
Besonderheiten	Characteristics	Particularités	Modernste High-Power-LEDs / State-of-the-art high power LEDs / LED haute puissance ultra-modernes
Lichtfarbe	Light color	Couleur de lumière	Weiß / White / Blanc
Abstrahlwinkel FWHM	Deflection angle FWHM	Angle d'émission FWHM	80°
Betriebsspannung	Service voltage	Tension de service	24 V DC (Supply Class 2)
Leistung	Power	Puissance	4,6 W / 24 V DC / 4.6 W / 24 V DC / 4,6 W / 24 V DC
Umgebungstemperatur Betrieb	Ambient temperature during operation	Température ambiante de fonctionnement	0 ... +40 °C
Schutzart	Protection type	Indice de protection	IP 67
Risikogruppe (DIN EN 62471)	Risk group (DIN EN 62471)	Groupe de risque (DIN EN 62471)	Risikogruppe 1 / Risk group 1 / Groupe de risque 1

Sicherheitshinweise	Safety instructions	Consignes de sécurité
<p>Allgemeiner Sicherheitshinweis WARNUNG! Kein Sicherheitsbauteil gemäß 2006/42/EG und EN 61496-1/-2! Darf nicht zum Personenschutz eingesetzt werden! Nichtbeachtung kann zu Tod oder schwersten Verletzungen führen! Nur bestimmungsgemäß verwenden!</p>	<p>General safety notice WARNING! Not a safety component pursuant to 2006/42/EG and EN 61496-1/-2! May not be used for personal protection! Non-compliance can lead to death or serious injuries! Only use as directed!</p>	<p>Consigne de sécurité générale AVERTISSEMENT ! Ce produit n'est pas un composant de sécurité au sens des réglementations 2006/42/CE et NF EN 61496-1/-2 ! Ne pas l'utiliser pour la protection des personnes ! Le non-respect de cette consigne peut entraîner la mort ou des blessures graves ! N'utiliser le produit que selon son utilisation conforme !</p>

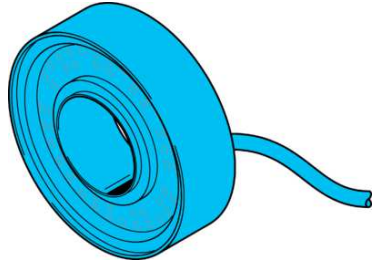

di-soric GmbH & Co. KG
 Steinbeisstraße 6
 DE-73660 Urbach
 Germany
 Tel: +49 (0) 7181/9879-0
 info@di-soric.com · www.di-soric.com

209554



版本 24.07.16, 保留变更权

 Enclosure Type 1 Supply Class 2
 NFPA 79 Applications only. For ad-
 apters providing field wiring me-
 ans refer to product information or
 customer support.
IND. CONT. EQ.
 29W7

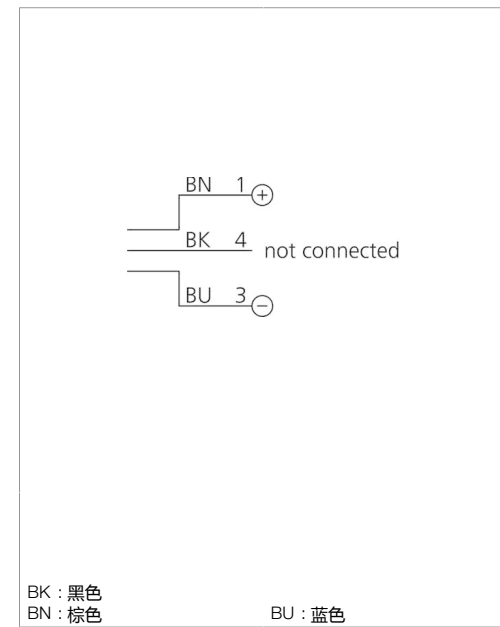
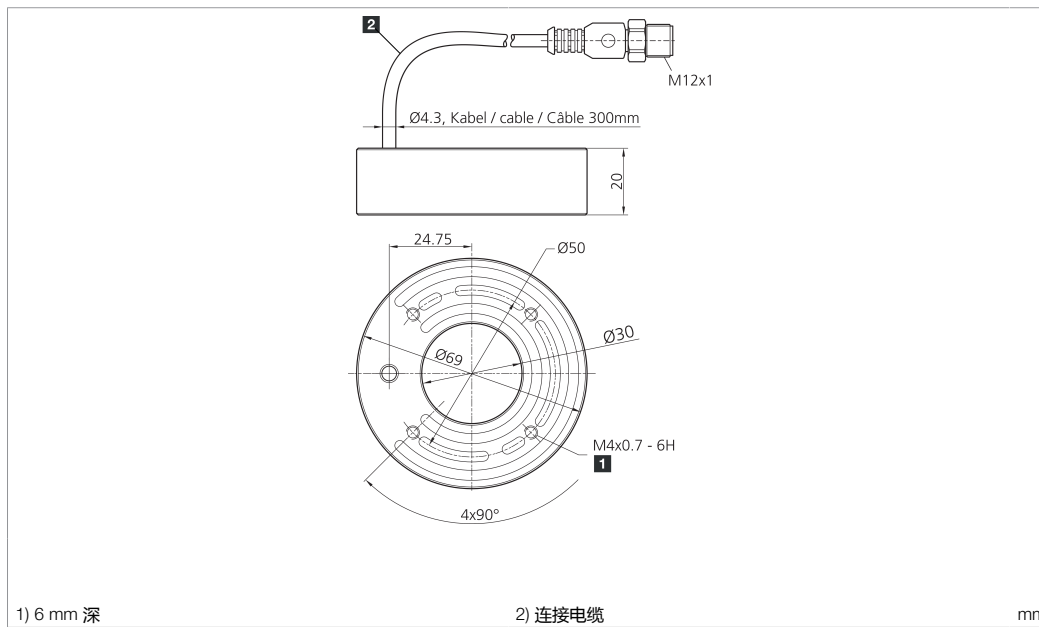

技术数据	+20°C, 24 V DC
特点	最先进的 High-Power-LED
光色	白色
发射角 FWHM	80°
工作电压	24 V DC (Supply Class 2)
功率	4.6 W / 24 V DC
工作环境温度	0 ... +40 °C
防护等级	IP 67
风险组 (DIN EN 62471)	风险组 1

安全提示
一般安全提示
 警告！没有符合 2006/42/EU 和 EN 61496-1 /-2 标准的安全结构件！不得用于人身安全保护！不遵守规定会导致死亡或重伤危险！仅按规定使用！

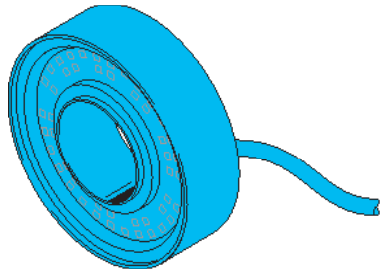

Ringbeleuchtung

- 

Nicht dauerhaft in den Lichtstrahl blicken!

- 

Diese Beleuchtung erzeugt eine sichtbare oder unsichtbare Strahlung, welche bei dauerhafter Einwirkung schädlich sein kann!

- 

Wärme Konvektion gewährleisten!

Die Erwärmung der Beleuchtung hat einen direkten Einfluss auf die Alterung/Lebensdauer der Beleuchtungs-LEDs! Je höher die Temperatur, desto stärker die Alterung.

- 

- Beleuchtung nicht abdecken

- Beleuchtungsintensität an die Applikation anpassen (überschüssige Lichtstärke vermeiden)

- Dauerlicht reduzieren/vermeiden (Triggerfunktion nutzen)

- Beleuchtung bei längerer Nichtnutzung abschalten

- 

Betriebswärme folgendermaßen abführen:

- Montage an eine kühlende Fläche (Maschinenkörper)

- Montage an einen externen Kühlkörper

- 

Regelmäßige Reinigung!

Starke Verschmutzung verhindert den Lichtaustritt und erhöht die Wärmeentwicklung.

Ringlight

- 

Do not look into the light beam for a prolonged period of time!

- 

This light produces radiation which may or may not be visible and prolonged exposure may be harmful!

- 

Ensure heat convection!

The heating of the light has a direct impact on the ageing/lifetime of the light LEDs! The higher the temperature, the faster the ageing process.

- 

- Do not cover the light

- Adapt the light intensity to the application (avoid excessive light intensity)

- Reduce/avoid continuous light (use trigger function)

- Switch off light when it is not being used for longer periods of time

- 

Dissipate operating heat as follows:

- Install on a cool surface (machine structure)

- Install on an external cooling element

- 

Clean on a regular basis!

Heavy contamination prevents light emission and increases heat development.

Anneau lumineux

- 

Ne pas regarder le rayon lumineux pendant une période de temps prolongée!

- 

Cette lumière produit des radiations qui pourraient ou ne pourraient pas être visibles et une exposition prolongée peut être nuisible!

- 

Protéger de l'émission de chaleur!

La chaleur émise par la lumière a un effet direct sur le vieillissement/la durée de vie des LED! Plus la température s'élève, plus rapide est le processus de vieillissement.

- 

- Ne pas couvrir la lumière

- Adapter l'intensité lumineuse en fonction de la nécessité de l'application (éviter l'excès d'intensité lumineuse)

- Réduire/éviter l'éclairage continu (utiliser la fonction de déclenchement)

- Éteindre l'éclairage lorsqu'il n'est pas utilisé pendant de longues périodes

- 

Dissiper la chaleur d'émission comme suit:

- Installer sur une surface froide (structure de la machine)

- Installer sur un élément refroidissant externe

- 

Nettoyer régulièrement

L'encrassement entrave la bonne émission de l'éclairage et accroît l'émission de chaleur.