

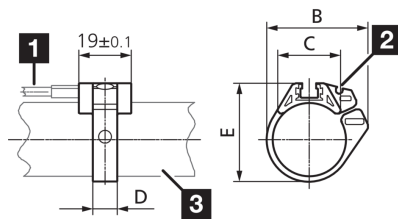

**202779**  
**MZ-S-10/6.5**  
**Sensor clamp**

- Reliable mounting of cylinder sensors at round cylinders
- High locking power
- Robust housing
- For quick and easy mounting of sensors

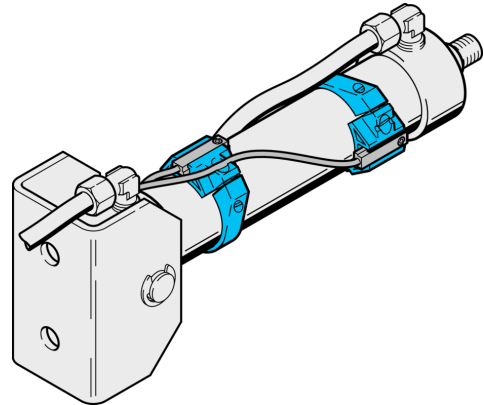

- 1) Sensor  
2) Guide groove for connecting line  
3) Round cylinder

#### Technical data (typ.)

Cylinder groove	T-groove
Assembly	at round cylinders
Distance dimension	B: 20.4 mm
Distance dimension	C: 13.7 mm
Distance dimension	D: 7 mm
Distance dimension	E: 19.9 mm
Housing material	Aluminum
Material	POM (Ring)
Component	Sensor clamp
To be used for	Ø 10 mm
Scope of delivery	Sensor holder, Fixing material

#### More information / accessories

<https://www.di-soric.com/202779>