

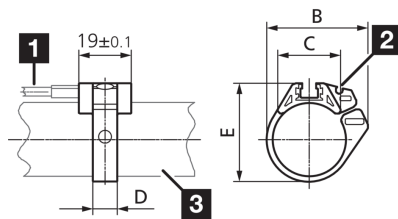

202785
MZ-S-40/6.5
Sensor clamp

- Reliable mounting of cylinder sensors at round cylinders
- High locking power
- Robust housing
- For quick and easy mounting of sensors

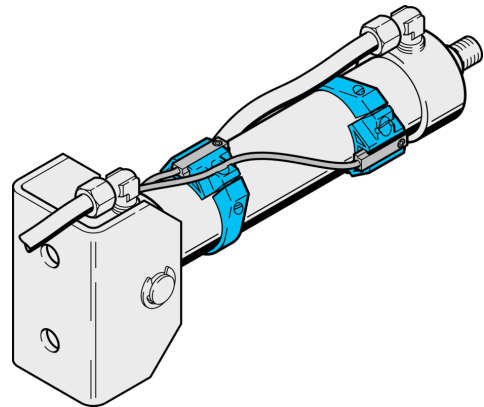

- 1) Sensor
 2) Guide groove for connecting line
 3) Round cylinder

Technical data (typ.)

Cylinder groove	T-groove
Assembly	at round cylinders
Distance dimension	B: 47.1 mm
Distance dimension	C: 26.5 mm
Distance dimension	D: 9 mm
Distance dimension	E: 50.7 mm
Housing material	Aluminum
Material	POM (Ring)
Component	Sensor clamp
To be used for	Ø 40 mm
Scope of delivery	Sensor holder, Fixing material

More information / accessories

<https://www.di-soric.com/202785>