

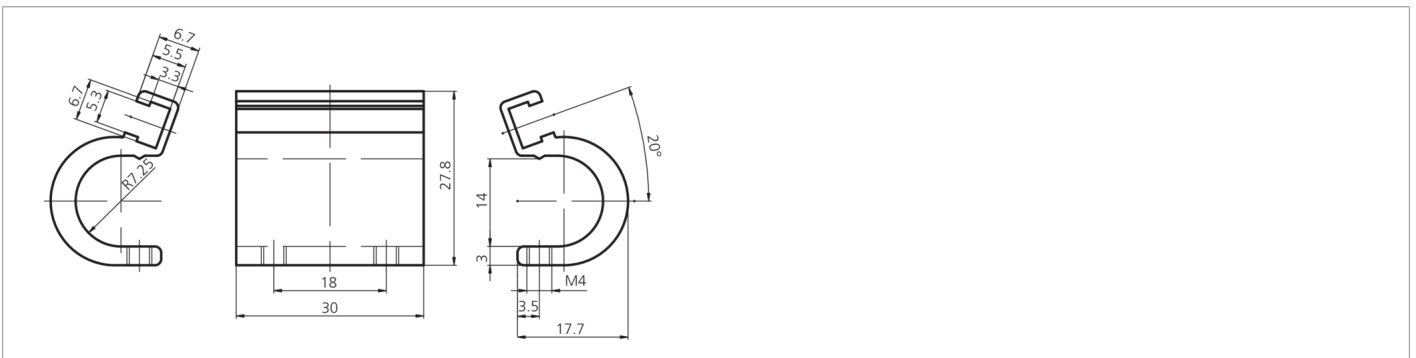

202793
MZ-K-14/6.5
Sensor bracket

- Reliable mounting of cylinder sensors at profiled cylinders
- High locking power
- Robust metal housing
- For quick and easy mounting of sensors

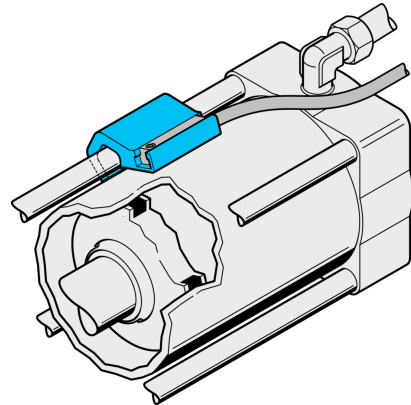

Technical data (typ.)	
Cylinder groove	T-groove
Assembly	at profiled cylinders
Housing material	Aluminum
Component	Sensor bracket
To be used for	Ø 50-63 mm
Scope of delivery	Sensor bracket, Fixing material
More information / accessories	https://www.di-soric.com/202793