

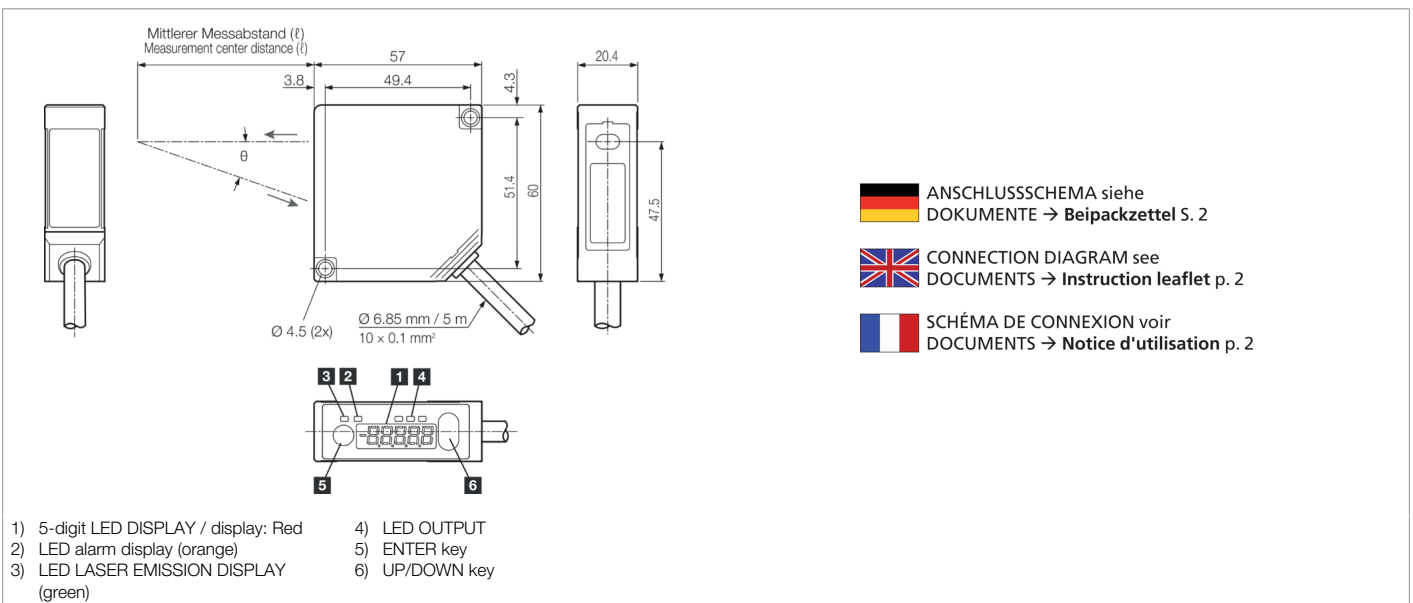

206990
LAT 61 K 30/8 IUPN
Laser distance sensors

- High precision
- Fast distance measurement
- Measured values on display
- 2 analog and 3 digital outputs
- Timing/ and multifunction input
- Light design for mounting on moving parts
- Measured values on display



Function									

Technical data (typ.)	+20°C, 24 V DC
Service voltage	21.6 ... 26.4 V DC
No-load current (max.)	100 mA
Insulation voltage endurance	250 V
Housing dimensions	60 x 57 x 20 mm
Housing material	Plastic
Material window / optics	Plastic
Weight	320 g
Protection class	III, operation on protective low voltage
Design	Cuboid design
Switching output	pnp/npn (3x), 50 mA, NO/NC, configurable
Voltage drop (max.)	2.8 V
Analog output	0 ... 10 V, 4 ... 20 mA
Light source	Laser
Laser class	2 (IEC 60825-1)
Color	red
Wavelength	665 nm
Light spot size	0.1 x 0.1 mm
Measuring range	26 ... 34 mm



206990

LAT 61 K 30/8 IUPN

Laser distance sensors

Technical data (typ.)	+20°C, 24 V DC
Resolution	0.5 µm (Median value 1024)
Linearity error	± 0.008 mm (Median value 1024)
Sensitivity adjustment	Keypad
Display	LED (Output status) Green - Status, yellow - Switching output, Red - Signal weak, orange - Signal weak
Measuring frequency	500 ... 5000 Hz
Ambient temperature during operation	-10 ... +45 °C
Temperature drift	0.08 %/K
Vibration/shock resistance	10 ... 500 Hz / 1.5 mm / 10 G
Protection type	IP 67
Connection	Cable, 5.0 m, 10-pin (Shielded, flying leads)
More information / accessories	https://www.di-soric.com/206990