

208267
HS-K-12-12-A
Cross connector

- Highly flexible versatile mounting system
- Universal mounting
- Stepless adjustment
- Robust design

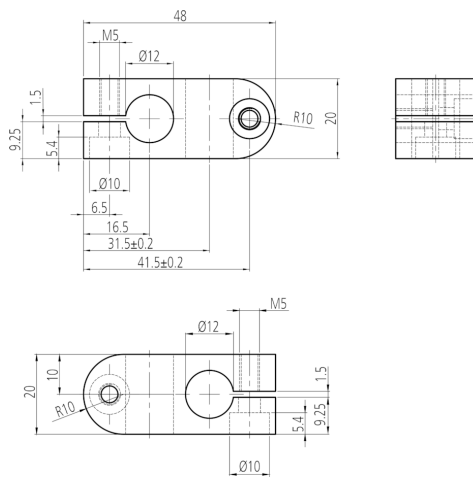
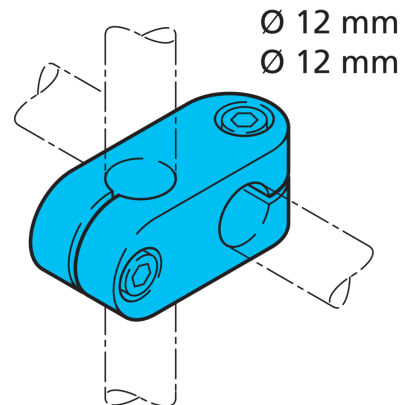

Technical data (typ.)

Dimension	+20°C Ø 12 / Ø 12 mm (Diameter Mounting pin / boring)
Housing material	Aluminum
Component	Cross connector
Product series	Z-UBT-KL-MS Assembly system

More information / accessories

<https://www.di-soric.com/208267>