

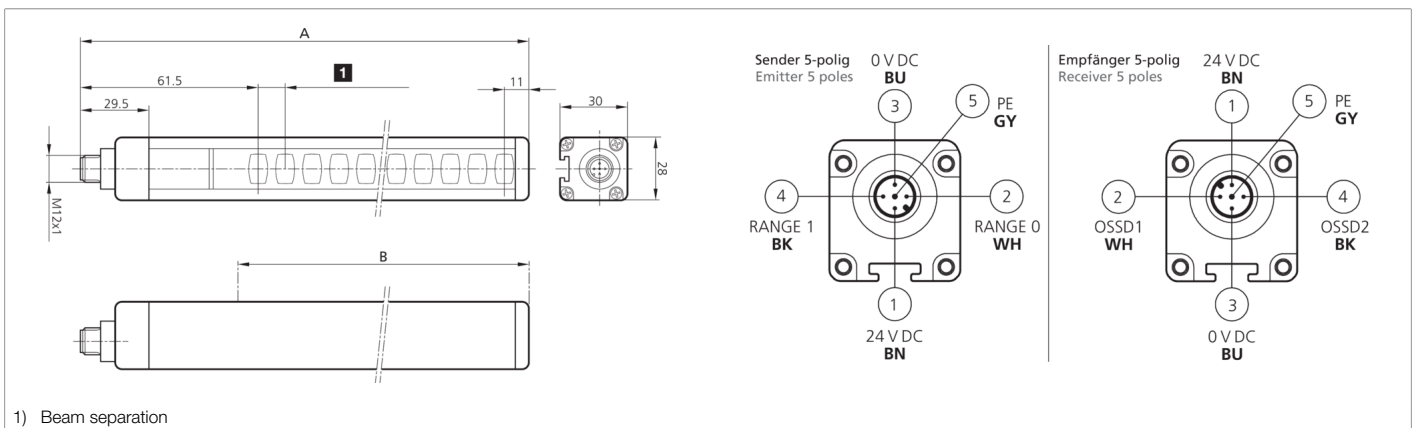

208520
SLB4-601
Safety light curtain

- Highest safety level
- Resolution for finger protection
- Protective range to profile end
- Parameterization via connecting cable
- Easy and fast startup
- Automatic Start/Restart
- For Modular Safety Controller / safety relays
- Unshielded connecting cables up to 100 m
- High protection type



Function										

Technical data (typ.)	+20°C, 24 V DC
Service voltage	19.2 ... 28.8 V DC
Inverse polarity protection	Yes
Short-circuit protection	Yes
Total height (A)	663 mm
Mounting	T-groove (backside), / Holder SFB E 180 (optional)
Housing material	Aluminum
Material	Polycarbonate (Window)
Characteristic variables	Typ 4, Typ 4 (IEC/TS 61496-2), SIL 3 (IEC 61508), SILCL 3 (IEC 62061), PL e - Kat. 4 (EN ISO 13849-1)
Protective function	Finger protection
Protection class	III, operation on protective low voltage
Model	Basic
Start / restart	Automatic
Scope of delivery	Transmitter + receiver, one set of standard fixing brackets SA 4, CD-ROM containing the multi-language operating instructions, Quick installation guide
Safety output	pnp (2x), 400 mA / 24 V DC
Light source	LED
Color	Infrared
Wavelength	950 nm
Number of beams	60
Protective field height (B)	610 mm
Range	3000 mm (Low range) / 6000 mm (High range)
Resolution	14.0 mm



208520

SLB4-601

Safety light curtain

Technical data (typ.)	+20°C, 24 V DC
Display	LED (Self-diagnosis and status of light barrier)
Reaction time	9 ms
Ambient temperature during operation	-20 ... +55 °C
Protection type	IP 65 / IP 67
Connection	Connector, M12, 5-pin (Transmitter)
Connection 2	Connector, M12, 5-pin (Receiver)
Cable	unshielded connection cables max. 100 m
More information / accessories	https://www.di-soric.com/208520