

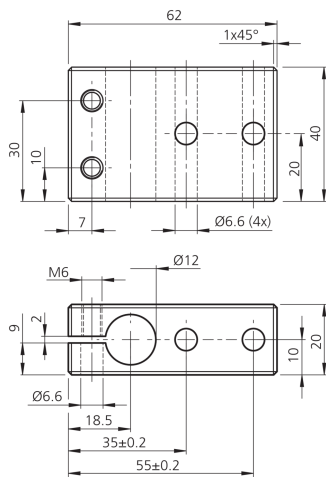

209458
HS-GH-12-A
Basic holder

- Highly flexible versatile mounting system
- Universal mounting
- Stepless adjustment
- Robust design

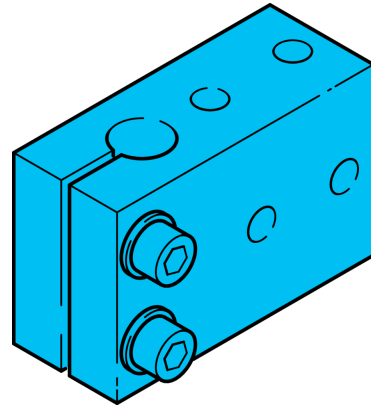

Technical data (typ.)

Dimension	+20°C Ø 12 mm (Diameter Mounting pin / boring)
Housing material	Aluminum
Component	Basic holder
Product series	Z-UBT-KL-MS Assembly system

More information / accessories

<https://www.di-soric.com/209458>