

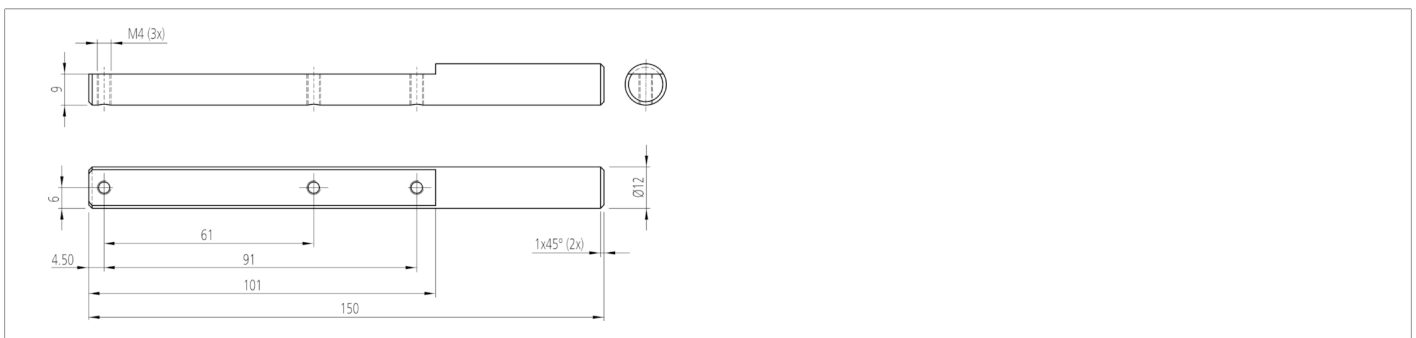

209479
HS-PH-12-150-V
Product holder

- Highly flexible versatile mounting system
- Universal mounting
- Stepless adjustment
- Robust design

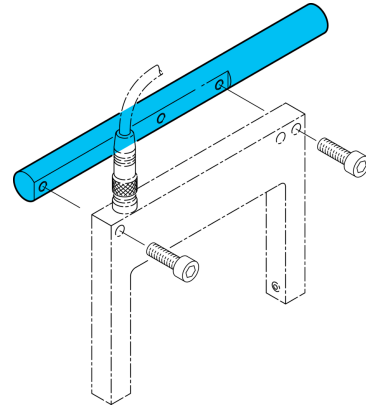

Technical data (typ.)

Dimension	+20°C Ø 12 mm (Diameter Mounting pin / boring)
Housing material	Stainless steel
Component	Product holder
To be used for	OGUxx 08x fork light barriers...
Product series	Z-UBT-KL-PH Product bracket

More information / accessories

<https://www.di-soric.com/209479>