

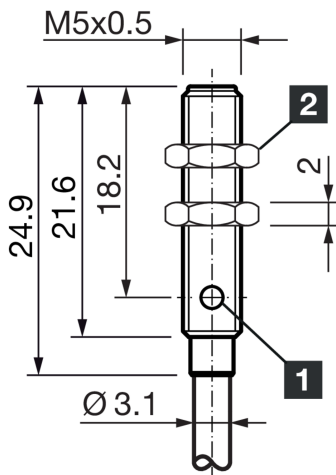

**210401**  
**DCC 05 V 0.8 PSLK/2mPUR**  
**Inductive proximity sensor**

- Stainless steel housing
- Highly flexible cable
- Integrated amplifier
- Short-circuit protection
- Starting pulse suppression
- LED



1) LED    2) Width over flats 7 mm    BK: black    BN: brown    BU: blue

**Function**



**Technical data (typ.)**

**+20°C, 24 V DC**

Service voltage	10 ... 30 V DC
Internal power consumption	< 10 mA
Insulation voltage endurance	500 V
Installation type	Flush
Thread	M5 x 0.5
Housing length	24.9 mm
Housing material	Stainless steel (AISI303)
Material of cable	Polyurethane
Material of sensor probe	PBT
Tightening torque (max.)	1.5 Nm
Protection class	III, operation on protective low voltage
Operating principle	inductive
Evaluation	digital
Design	Thread
Product series	INM-100 Miniature
Switching output	pnp, 100 mA, NO
Voltage drop (max.)	1.5 V (100 mA)
Switching distance (SN)	0.8 mm
Standardized measuring plate	4 x 4 x 1 mm
Switching hysteresis (max.)	1 ... 20 %



**210401**  
**DCC 05 V 0.8 PSLK/2mPUR**  
**Inductive proximity sensor**

**Technical data (typ.)**

**+20°C, 24 V DC**

LED Anzeige

Yes

Switching frequency

5000 Hz

Ambient temperature during operation

-25 ... +70 °C

Protection type

IP 67

Connection

Cable, 2.0 m (flying leads)

**More information / accessories**

<https://www.di-soric.com/210401>