

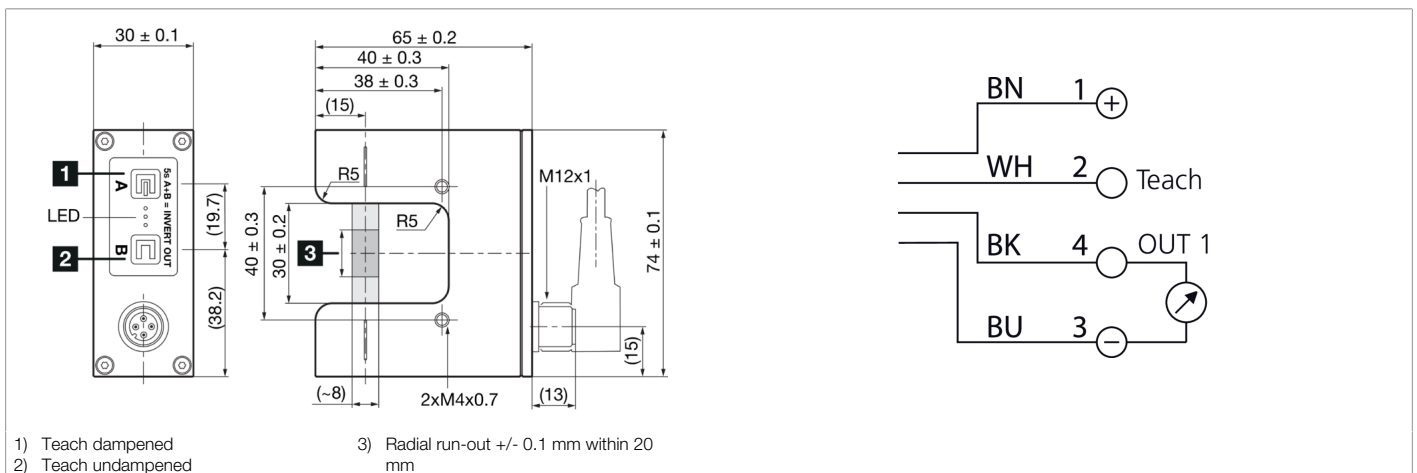

213497
USGT 30/8 IU-B4
Ultrasonic fork barrier

- Large linearized analog range
- Very high repeatability
- Web edge control also with transparent materials
- Resistant to dirt



Function											

Technical data (typ.)	+20°C, 24 V DC
Service voltage	12 ... 30 V DC
No-load current (max.)	40 mA (24 V DC)
Ripple	10 %
Insulation voltage endurance	500 V
Housing material	Aluminum (Black, Anodized)
Protection class	III, operation on protective low voltage
Approvals	UL
Operating principle	Ultrasonic through-beam sensor
Evaluation	analog
Design	Fork
Analog output	0 ... 10 V, 4 ... 20 mA
Fork opening	30 mm
Resolution	0.1 mm
Measuring range	8 mm (typ.)
Reproducibility	± 0.1 mm
Sensitivity adjustment	Keypad
Measuring frequency	500 Hz
Ambient temperature during operation	0 ... +60 °C
Protection type	IP 67
Connection	Connector, M12, 4-pin
Connection cable	VKHM ... /4



213497

USGT 30/8 IU-B4

Ultrasonic fork barrier

[More information / accessories](#)

<https://www.di-soric.com/213497>