

VSHM-Z-0.6/TKM-Z

Verbindungskabel: Stecker / Kupplung
 Connection cable: Connector / coupling
 Câble de liaison : connecteur / couplage

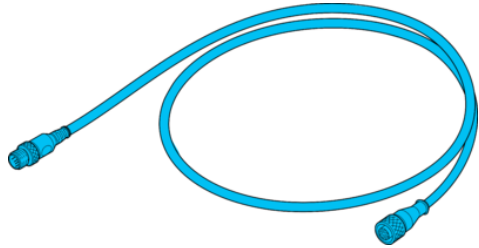

di-soric GmbH & Co. KG
 Steinbeisstraße 6
 DE-73660 Urbach
 Germany
 Tel: +49 (0) 7181/9879-0
 info@di-soric.com · www.di-soric.com

203679

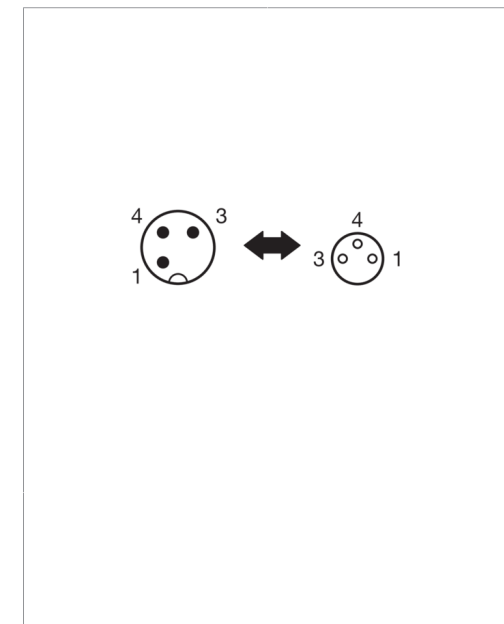
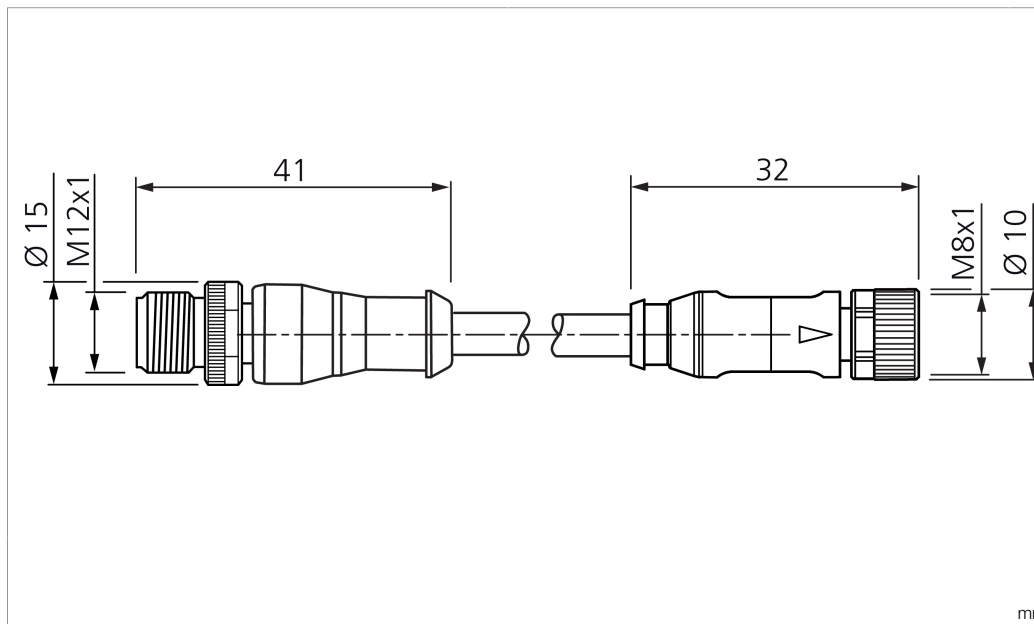

Technische Daten	Technical data	Caractéristiques techniques	+20°C
Betriebsspannung	Service voltage	Tension de service	< 60 V AC/DC
Schutzart	Protection type	Indice de protection	IP 67 (bei Anzugsmoment 0,4 Nm) / IP 67 (at tightening torque 0.4 Nm) / IP 67 (à un couple de serrage de 0,4 Nm)
Umgebungstemperatur Betrieb	Ambient temperature during operation	Température ambiante de fonctionnement	-5 ... +80 °C
Anschluss 1	Connection 1	Raccordement 1	Stecker, M12, 3-polig, A-kodiert / Connector, M12, 3-pin, A-coded / Connecteur, M12, 3 pôles, Codage A
Anschluss 2	Connection 2	Raccordement 2	Buchse, M8, 3-polig, A-kodiert / Socket, M8, 3-pin, A-coded / Connecteur femelle, M8, 3 pôles, Codage A
Kabellänge	Cable length	Longueur de câble	600 mm

Stand 17.05.24, Änderungen vorbehalten
 As of 05/17/24, subject to change
 État 17.05.24, sous réserve de modifications



Sicherheitshinweise	Safety instructions	Consignes de sécurité
Allgemeiner Sicherheitshinweis WARNUNG! Kein Sicherheitsbauteil gemäß 2006/42/EG und EN 61496-1 /-2! Darf nicht zum Personenschutz eingesetzt werden! Nichtbeachtung kann zu Tod oder schwersten Verletzungen führen! Nur bestimmungsgemäß verwenden!	General safety notice WARNING! Not a safety component pursuant to 2006/42/EG and EN 61496-1/-2! May not be used for personal protection! Non-compliance can lead to death or serious injuries! Only use as directed!	Consigne de sécurité générale AVERTISSEMENT ! Ce produit n'est pas un composant de sécurité au sens des réglementations 2006/42/CE et NF EN 61496-1/-2 ! Ne pas l'utiliser pour la protection des personnes ! Le non-respect de cette consigne peut entraîner la mort ou des blessures graves ! N'utiliser le produit que selon son utilisation conforme !

VSHM-Z-0.6/TKM-Z

连接电缆：公头 / 母头

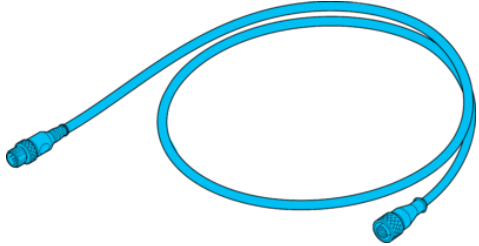

di-soric GmbH & Co. KG
 Steinbeisstraße 6
 DE-73660 Urbach
 Germany
 Tel: +49 (0) 7181/9879-0
 info@di-soric.com · www.di-soric.com

203679

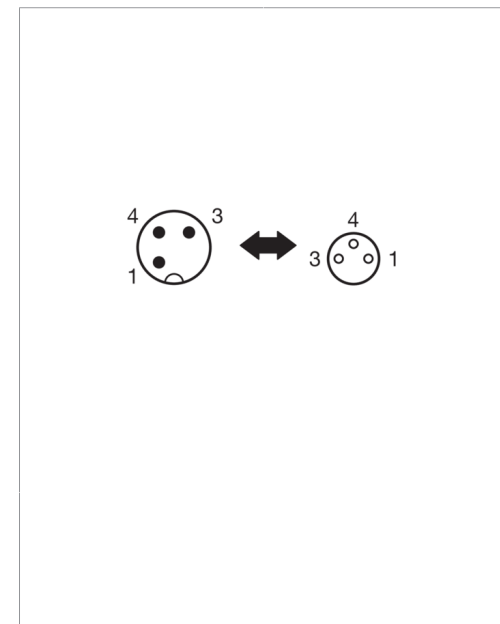
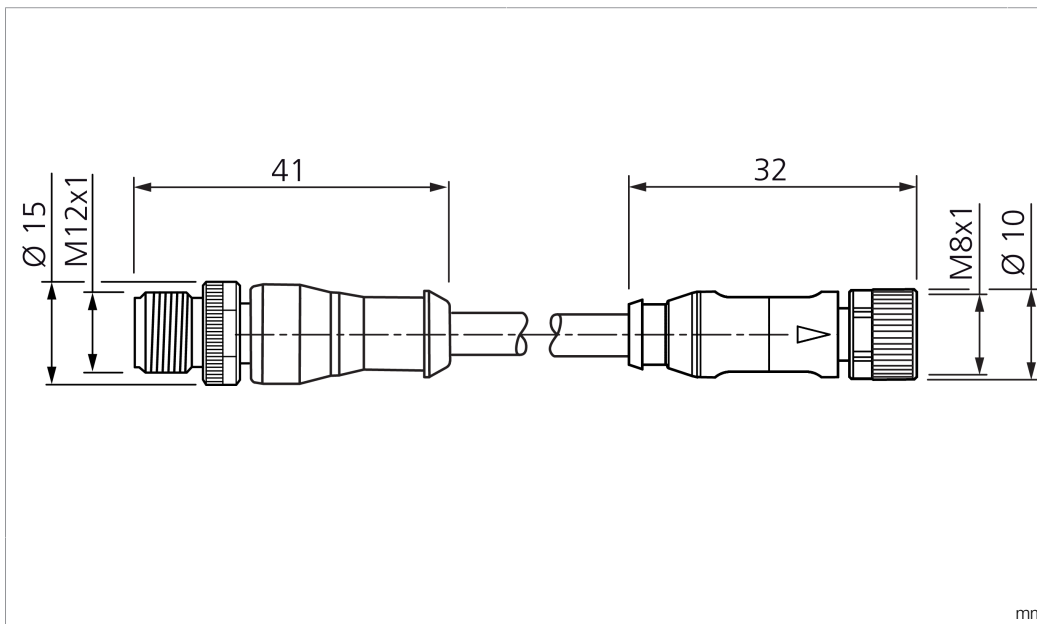

技术数据

工作电压

防护等级

工作环境温度

连接 1

连接 2

电缆长度

+20°C

< 60 V AC/DC

IP 67 (拧紧力矩为 0.4 Nm 时)

-5 ... +80 °C

插头, M12, 3 针, A 编码

插口, M8, 3 针, A 编码

600 mm

版本 24.05.17, 保留变更权



安全提示



一般安全提示

警告！没有符合 2006/42/EU 和 EN 61496-1 /-2 标准的安全结构件！不得用于人身安全保护！不遵守规定会导致死亡或重伤危险！仅按规定使用！