

HS-AG-NG-KK-VS-M8/M6

Saugnapfhalterung
Suction cup fastener
Support à ventouse

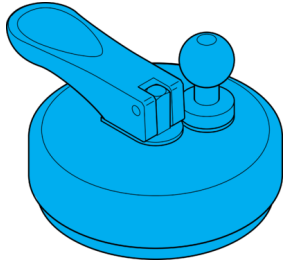

di-soric GmbH & Co. KG
Steinbeisstraße 6
DE-73660 Urbach
Germany
Tel: +49 (0) 7181/9879-0
info@di-soric.com · www.di-soric.com

213466

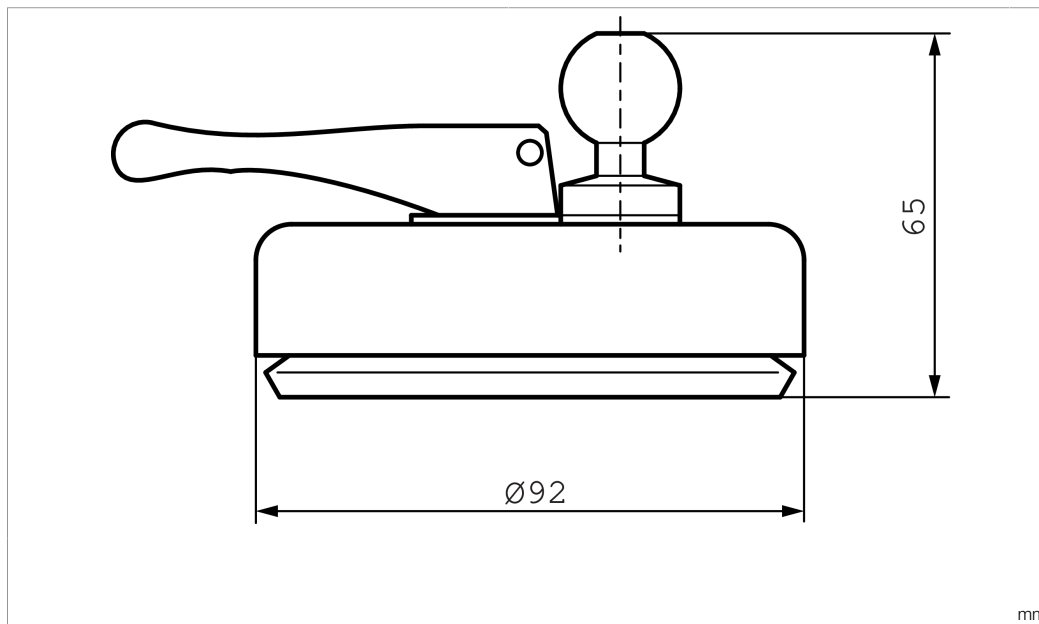

Technische Daten	Technical data	Caractéristiques techniques	
Komponente	Component	Composants	Saugnapfhalterung / Suction cup fastener / Support à ventouse
Geeignet für	To be used for	Convient pour	Z-UBT-KU-MS
Gehäuseabmaße	Housing dimensions	Dimensions du boîtier	65 x 92 mm
Tragkraft	Load capacity	Capacité de chargement	60 N / 6 kg
Gehäusematerial	Housing material	Matériau du boîtier	Aluminium / Aluminum / Aluminium
Lieferumfang	Scope of delivery	Contenu de la livraison	Saugnapf, Kugelkopf, Adapterschraube / Suction cup, Ball head, Adapter screw / Ventouse, Tête sphérique, Vis d'adaptation

Stand 03.11.23, Änderungen vorbehalten

As of 11/03/23, subject to change

État 03.11.23, sous réserve de modifications

Sicherheitshinweise	Safety instructions	Consignes de sécurité
Allgemeiner Sicherheitshinweis WARNUNG! Kein Sicherheitsbauteil gemäß 2006/42/EG und EN 61496-1 /-2! Darf nicht zum Personenschutz eingesetzt werden! Nichtbeachtung kann zu Tod oder schwersten Verletzungen führen! Nur bestimmungsgemäß verwenden!	General safety notice WARNING! Not a safety component pursuant to 2006/42/EG and EN 61496-1/-2! May not be used for personal protection! Non-compliance can lead to death or serious injuries! Only use as directed!	Consigne de sécurité générale AVERTISSEMENT ! Ce produit n'est pas un composant de sécurité au sens des réglementations 2006/42/CE et NF EN 61496-1/-2 ! Ne pas l'utiliser pour la protection des personnes ! Le non-respect de cette consigne peut entraîner la mort ou des blessures graves ! N'utiliser le produit que selon son utilisation conforme !

HS-AG-NG-KK-VS-M8/M6

带球头的吸盘支架

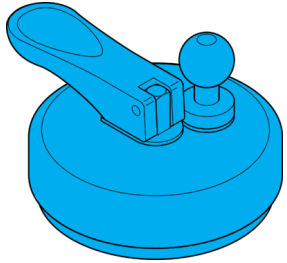

di-soric GmbH & Co. KG
Steinbeisstraße 6
DE-73660 Urbach
Germany
Tel: +49 (0) 7181/9879-0
info@di-soric.com · www.di-soric.com

213466

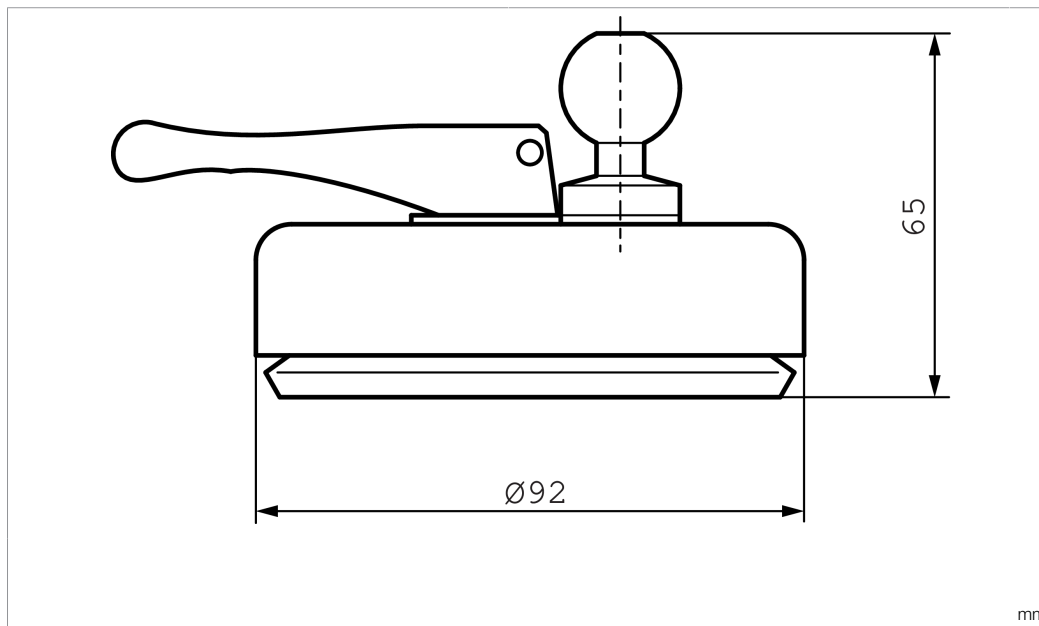
**技术数据**

组件	带球头的吸盘支架
适合用于	Z-UBT-KU-MS
外壳尺寸	65 x 92 mm
承载能力	60 N / 6 kg
外壳材料	铝
供货范围	吸盘, Ball head, Adapter screw

版本 23.11.03, 保留变更权

安全提示**一般安全提示**

警告！没有符合 2006/42/EU 和 EN 61496-1 /-2 标准的安全结构件！不得用于人身安全保护！不遵守规定会导致死亡或重伤危险！仅按规定使用！