

OGUFIX 031 P1K-TSSL

Gabellichtschranke
Fork light barrier
Fourche optique

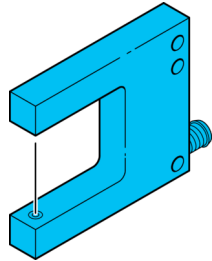

di-soric GmbH & Co. KG
Steinbeisstraße 6
DE-73660 Urbach
Germany
Tel: +49 (0) 7181/9879-0
info@di-soric.com · www.di-soric.com

203096

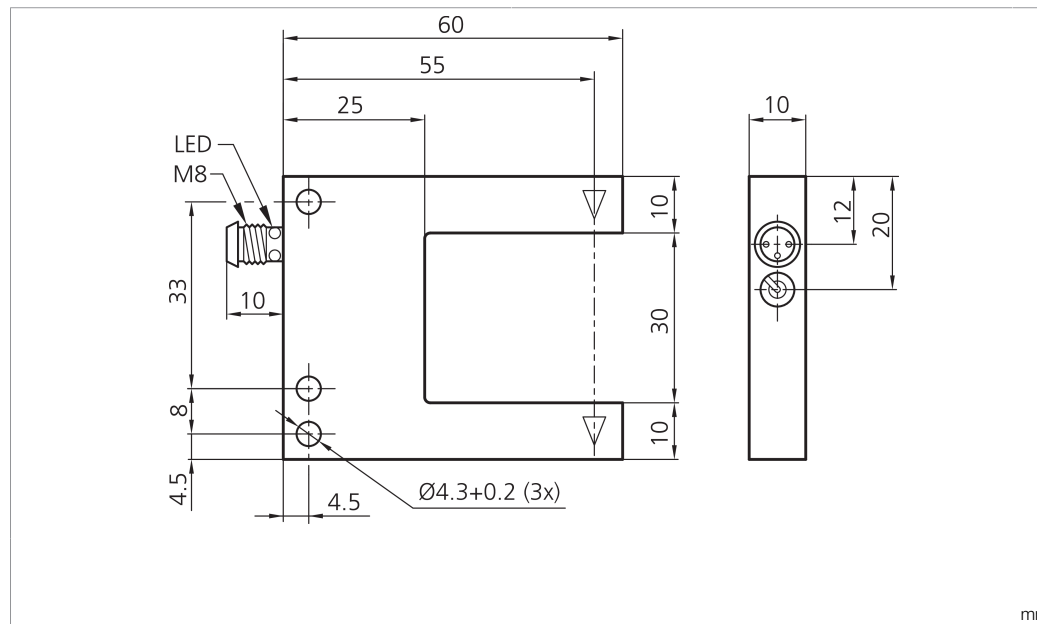

BK : schwarz / black / noir
BN : braun / brown / marron BU : blau / blue / bleu

Technische Daten	Technical data	Caractéristiques techniques	+20°C, 24 V DC
Sendelichtquelle	Transmitter light source	Source lumineuse émetteur	LED
Lichtfarbe	Light color	Couleur de lumière	Rot / 660 nm / red / 660 nm / Rouge / 660 nm
Betriebsspannung	Service voltage	Tension de service	10 V ... 35 V DC (Supply Class 2)
Leerlaufstrom (max.)	No-load current (max.)	Courant de marche à vide (max.)	30 mA
Schaltausgang	Switching output	Sortie de commutation	pnp, 200 mA, NC
Umgebungstemperatur Betrieb	Ambient temperature during operation	Température ambiante de fonctionnement	-10 ... +60 °C
Schutzart	Protection type	Indice de protection	IP 67

Stand 16.07.24, Änderungen vorbehalten

As of 07/16/24, subject to change

État 16.07.24, sous réserve de modifications

Funktion / Function / Fonction



Enclosure Type 1 Supply Class 2
NFPA 79 Applications only. For adapters providing field wiring means refer to product information or customer support.



Sicherheitshinweise



Allgemeiner Sicherheitshinweis

WARNUNG! Kein Sicherheitsbauteil gemäß 2006/42/EG und EN 61496-1/-2! Darf nicht zum Personenschutz eingesetzt werden! Nichtbeachtung kann zu Tod oder schwersten Verletzungen führen! Nur bestimmungsgemäß verwenden!

Safety instructions



General safety notice

WARNING! Not a safety component pursuant to 2006/42/EG and EN 61496-1/-2! May not be used for personal protection! Non-compliance can lead to death or serious injuries! Only use as directed!

Consignes de sécurité



Consigne de sécurité générale

AVERTISSEMENT ! Ce produit n'est pas un composant de sécurité au sens des réglementations 2006/42/CE et NF EN 61496-1/-2 ! Ne pas l'utiliser pour la protection des personnes ! Le non-respect de cette consigne peut entraîner la mort ou des blessures graves ! N'utiliser le produit que selon son utilisation conforme !

OGUFIX 031 P1K-TSSL

槽型光电开关

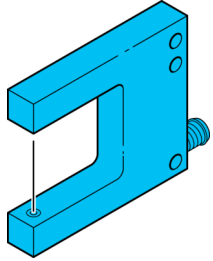

di-soric GmbH & Co. KG
Steinbeisstraße 6
DE-73660 Urbach
Germany
Tel: +49 (0) 7181/9879-0
info@di-soric.com · www.di-soric.com

203096

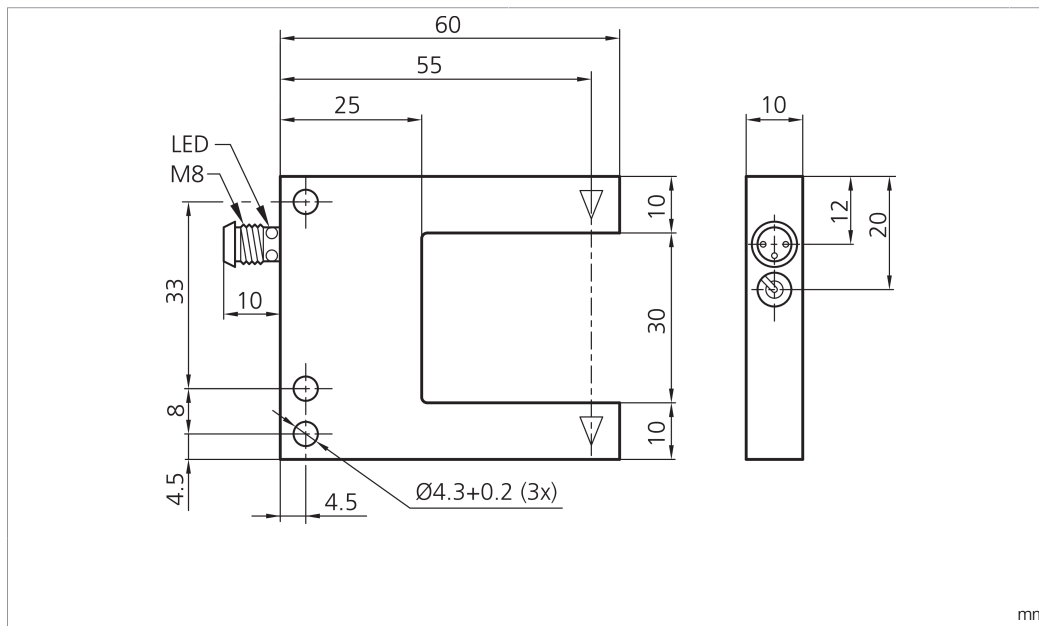

mm

BK : 黑色
BN : 棕色

BU : 蓝色

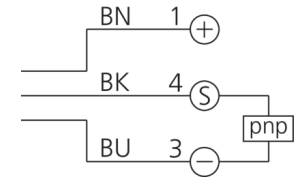

技术数据

发射光源

光色

工作电压

空载电流 (最大)

开关输出端

工作环境温度

防护等级

+20°C, 24 V DC

LED

红色 / 660 nm

10 V ... 35 V DC (Supply Class 2)

30 mA

pnp, 200 mA, NC

-10 ... +60 °C

IP 67

版本 24.07.16, 保留变更权

功能



Enclosure Type 1 Supply Class 2
NFPA 79 Applications only. For adapters providing field wiring means refer to product information or customer support.



安全提示



一般安全提示

警告！没有符合 2006/42/EU 和 EN 61496-1 /-2 标准的安全结构件！不得用于人身安全保护！不遵守规定会导致死亡或重伤危险！仅按规定使用！